

Anaga

UAB „Anaga“
Kauno g. 36, Vilnius
+370 5 2150738
info@anaga.lt
www.anaga.lt

PEDROLLO KAINYNAS 2020

Automatinės vandens tiekimo sistemos PEDROLLO



Pavadinimas	Hidroforo talpa, l	Išsiurbimo gylis, m	Galingumas, kW	Slėgis, m	Našumas, m ³ /val	Kaina, Eur su PVM		
PKm60-24 CL	20	7	0,37	5-38	2,4-0,3	149,00		
JSWm1BX-24 CL	20	9	0,5	12-34	3,6-0,3	190,00		
JSWm1AX-24 CL	20	9	0,55	17-43	3,6-0,3	200,00		
JCRm1AX-24 CL	20	9	0,55	17-43	3,6-0,3	220,00		
JSWm2CX-24 CL	20	9	0,75	20-47	4,2-0,3	228,00		
JSWm 2BX-24 CL	20	9	0,9	24-51	4,2-0,3	254,00		
JSWm2AX-24 CL	20	9	1,1	28-55	4,2-0,3	268,00		
JSWm2CX-50 CL	50	9	0,75	20-47	4,2-0,3	284,00		
JSWm2BX-60 CL	60	9	0,9	24-51	4,2-0,3	313,00		
JSWm2AX-60CL	60	9	1,1	28-55	4,2-0,3	324,00		
JSWm2BX-100 CL	100	9	0,9	24-51	4,2-0,3	385,00		
JSWm1AX-100 CL	100	9	0,55	17-43	3,6-0,3	355,00		
JSWm1BX-24 APT	24	9	0,5	12-34	3,6-0,3	207,00		
JSWm1AX-24 APT	24	9	0,55	17-43	3,6-0,3	216,00		
PLURIJETm4/80-24 APT	24	9	0,55	10-50	4,8-0,3	293,00		
JSWm2CX-24 APT	24	9	0,75	20-47	4,2-0,3	273,00		
JSWm2AX-24 APT	24	9	1,1	28-55	4,2-0,3	311,00		
JSWm2CX-60 APT	58	9	0,75	20-47	4,2-0,3	335,00		
JSWm2BX-60 APT	58	9	0,9	24-51	4,2-0,3	364,00		
PLURIJETm4/80-60 APT	60	9	0,55	10-50	4,8-0,3	373,00		
JSWm2CX-80 APT	80	9	0,75	20-47	4,2-0,3	362,00		
JSWm2BX-80 APT	80	9	0,9	24-51	4,2-0,3	399,00		
JDWm1AX/30-24 CL	20	20	0,75	18-42	1,0-0,12	297,00		
JDWm2A/30-24 CL	20	30	1,1	30	0,96	406,00		
JDWm2A/30-60 CL	60	30	1,1	30	0,96	485,00		

GARANTIJA SIURBLIAMS – 24 MĖNESIAI, HIDROFORAMS APT – 60 MĖNESIU

Automatinės vandens tiekimo sistemos su dažnio keitikliu DG PED

Pavadinimas	Hidroforo talpa, l	Išsiurbimo gylis, m	Galingumas, kW	Slėgis, m	Našumas, m ³ /val	Kaina, Eur su PVM	
DG PED 3	-	8	0,75	10-55	4,8-0,3	650,00	
DG PED 5	-	8	1,1	10-55	7,2-0,3	800,00	

Papildomi aksesuarai sistemoms DG PED

Kodas	Pavadinimas	Kaina, Eur
ASSKITDGP01	Dviejų DG PED siurblių pajungimo komplektas	340,00
ASSKITDGP02	Sienos montavimo komplektas vienam DG PED siurbliui	60,00
ASSKITDGP03	Sienos montavimo komplektas dviems DG PED siurbliams	85,00
ASSKITDGP04	Elektroninė išplėtimo plokštė	85,00



Šis įrenginys savyje turi visą vandens tiekimo sistemą - vandens siurbį, dažnio keitiklį, slėgio jutiklį, išsiplėtimo indą ir atbulinį vožtuvą. Šių komponentų pagalba, siurblys automatiškai, nepriklausomai nuo atidarytų čiaupų skaičiaus, palaiko pastovų slėgį sistemoje, keisdamas variklio apsisukimų dažnį.

Kompaktiški matmenys, paprastas pajungimas, lengvas ir patogus valdymas, žemas triukšmo lygis yra pagrindiniai šio siurblio privalumai. Naudojant išplėtimo plokštę, galima sujungti 2 įrenginius darbiui vienoje sistemoje.

Vandens siurbliai su dažnio keitikliu



Markė 230 V	Galia, kW	Slėgis, m	Našumas l/min	Pajungimo diametrai	Kaina 230V		
TS1-4CP 100	0,75	44-5	5-130	1"	859,00		
TS1-4CR 100	0,75	44-5	5-130	1"	879,00		
TS1-5CR 100	1,1	56-8	5-130	1"	896,00		
TS1-2CP 25/130	0,75	36-15	5-100	1 1/4" / 1"	890,00		
TS1-2CP 25/14B	1,1	48-22	5-100	1 1/4" / 1"	1012,00		
TS1-2CP 25/14A	1,5	61-32	5-110	1 1/4" / 1"	1145,00		
TS1-2CP 25/16C	1,1	41-24	5-120	1 1/4" / 1"	1012,00		
TS1-2CP 25/16B	1,5	52-30	5-140	1 1/4" / 1"	1145,00		
TS1-2CP 25/16A	2,2	62-32	5-160	1 1/4" / 1"	1166,00		
TS2-MK 3/3	0,75	46-28	5-80	1 1/4" / 1"	1145,00		
TS2-MK 3/4	1,1	62-38	5-80	1 1/4" / 1"	1166,00		
TS2-MK 3/5	1,1	80-47	5-80	1 1/4" / 1"	1187,00		
TS2-MK 3/6	1,5	96-56	5-80	1 1/4" / 1"	1330,00		
TS2-MK 5/4	1,1	50-20	5-120	1 1/4" / 1"	1166,00		
TS2-MK 5/5	1,1	63-25	5-120	1 1/4" / 1"	1187,00		
TS2-MK 5/6	1,5	78-30	5-120	1 1/4" / 1"	1330,00		
TS2-MK 5/7	1,8	92-34	5-120	1 1/4" / 1"	1352,00		
TS2-MK 5/8	2,2	102-40	5-120	1 1/4" / 1"	1362,00		
TS2-MK 8/4	1,5	50-15	5-180	1 1/4" / 1"	1309,00		
TS2-MK 8/5	1,8	64-18	5-180	1 1/4" / 1"	1330,00		
TS2-MK 8/6	2,2	80-20	5-180	1 1/4" / 1"	1341,00		
TIS2-5CR 90	1,1	78-38	5-90	1 1/4" / 1"	1256,00		
TIS2-6CR 90	1,5	94-45	5-90	1 1/4" / 1"	1415,00		
TIS2-7CR 90	1,8	110-53	5-90	1 1/4" / 1"	1473,00		
TIS2-3CR 130	1,1	49-24	5-130	1 1/4" / 1"	1187,00		
TIS2-4CR 130	1,5	65-31	5-130	1 1/4" / 1"	1352,00		
TIS2-5CR 130	1,8	81-39	5-130	1 1/4" / 1"	1405,00		
TIS2-6CR 130	2,2	97-46	5-130	1 1/4" / 1"	1442,00		
TIS2-3CR 200	1,1	43-13	5-200	1 1/4" / 1"	1187,00		
TIS2-4CR 200	1,5	57-17	5-200	1 1/4" / 1"	1352,00		
TIS2-5CR 200	1,8	72-22	5-200	1 1/4" / 1"	1405,00		
TIS2-6CR 200	2,2	86,26	5-200	1 1/4" / 1"	1442,00		
TIS2-PLURIJET 5/90	1,1	76-33	5-90	1 1/4" / 1"	1261,00		
TIS2-PLURIJET 6/90	1,5	93-43	5-90	1 1/4" / 1"	1420,00		
TIS2-PLURIJET 3/130	1,1	49-24	5-130	1 1/4" / 1"	1193,00		
TIS2-PLURIJET 4/130	1,5	65-31	5-130	1 1/4" / 1"	1357,00		
TIS2-PLURIJET 5/130	1,8	81-39	5-130	1 1/4" / 1"	1410,00		
TIS2-PLURIJET 6/130	2,2	97-46	5-130	1 1/4" / 1"	1447,00		
TIS2-PLURIJET 3/200	1,1	43-13	5-200	1 1/4" / 1"	1193,00		
TIS2-PLURIJET 4/200	1,5	57-17	5-200	1 1/4" / 1"	1357,00		
TIS2-PLURIJET 5/200	1,8	72-22	5-200	1 1/4" / 1"	1410,00		
TIS2-PLURIJET 6/200	2,2	86-26	5-200	1 1/4" / 1"	1447,00		

A klasės cirkuliaciniai siurbliai šildymo sistemoms PEDROLLO EEI≤0,2

Markė	Pajungimo diametrai	Galia, W	H, m	Q, m ³ /val	Kaina, EUR
DHL 25-60/130	1 1/2"	3 – 42	0,5 – 6,0	3,5 – 0,01	139,00
DHL 25-60/180	1 1/2"	3 – 42	0,5 – 6,0	3,5 – 0,01	139,00



Elektroninis valdymas, darbinė temperatūra nuo +2°C iki +95°C, kompaktiškas dizainas, sklaidi eiga, labai mažos energijos sąnaudos, galima nustatyti 3-is skirtingus valdymo režimus: proporcinis slėgis, fiksuotas greitis arba pastovus slėgis, specialiais dažais padengtas siurblio korpusas, triukšmo lygis ≤43 dB (A). **GARANTIJA – 24 MĖNESIAI**

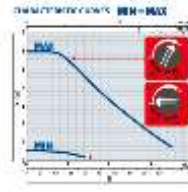
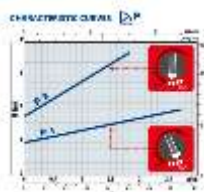



Markė 230 V	Markė 400V	Galia, kW	Slėgis, m	Našumas, l/min	Pajungimo diametrai	Kaina 230V	Kaina 400V		
PKM 60	PK 60	0,37	38-5	5-40	1"	87,00	113,00		
PKM 65	PK 65	0,5	50-8	5-50	1"	131,00	148,00		
PKM 70	PK 70	0,6	62-18	5-50	1"	172,00	191,00		
PKM 80	PK 80	0,75	66-22	5-50	1"	178,00	196,00		
PKM 90	PK 90	0,75	82-5	5-40	3/4"	214,00	232,00		
PKM 100	PK 100	1,1	80-15	5-70	1"	321,00	332,00		
PKM 200	PK 200	1,5	86-10	5-80	1"	355,00	355,00		
-	PK 300	2,2	95-10	5-90	1"	-	380,00		
PKSM 60	PKS 60	0,37	38-5	5-40	1"	107,00	126,00		
PKSM 65	PKS 65	0,50	50-8	5-50	1"	160,00	177,00		
PKSM 70	PKS 70	0,60	62-18	5-50	1"	191,00	208,00		
PKSM 80	PKS 80	0,75	66-22	5-50	1"	202,00	218,00		
PQM 60	PQ 60	0,37	38-5	5-40	1"	95,00	113,00		
PQM 65	PQ 65	0,50	50-8	5-50	1"	142,00	160,00		
PQM 70	PQ 70	0,60	62-18	5-50	1"	184,00	202,00		
PQM 80	PQ 80	0,75	66-22	5-50	1"	196,00	214,00		
PQM 90	PQ 90	0,75	82-5	5-40	3/4"	214,00	232,00		
PQM 100	PQ 100	1,1	80-15	5-70	1"	321,00	332,00		
PQM 200	PQ 200	1,5	86-10	5-80	1"	344,00	344,00		
-	PQ 300	2,2	95-10	5-90	1"	-	368,00		
-	PQ 3000	2,2	165-50	10-50	3/4"	-	604,00		
JSWM1CX	JSW1CX	0,37	32-10	5-60	1"	139,00	163,00		
JSWM1BX	JSW1BX	0,48	34-12	5-60	1"	123,00	178,00		
JSWM1AX	JSW1AX	0,55	43-17	5-60	1"	127,00	188,00		
JSWM2CX	JSW2CX	0,75	47-20	5-70	1"	146,00	220,00		
JSWM2BX	JSW2BX	0,9	51-24	5-70	1"	177,00	231,00		
JSWM2AX	JSW2AX	1,1	55-28	5-70	1"	205,00	242,00		
JCRM 1C	JCR 1C	0,37	32-10	5-60	1"	167,00	186,00		
JCRM 1B	JCR 1B	0,48	34-12	5-60	1"	172,00	191,00		
JCRM 1A	JCR 1A	0,55	43-17	5-60	1"	172,00	190,00		
JCRM 2C	JCR 2C	0,75	47-19	5-70	1"	214,00	232,00		
JCRM 2B	JCR 2B	0,9	52-23	5-70	1"	232,00	243,00		
JCRM 2A	JCR 2A	1,1	56-27	5-70	1"	208,00	226,00		
JSWM 3CH	JSW 3CH	1,1	60-31	10-70	1 1/4" / 1"	380,00	392,00		
JSWM 3BH	JSW 3BH	1,5	70-39	10-80	1 1/4" / 1"	404,00	404,00		
-	JSW 3AH	2,2	90-50	10-80	1 1/4" / 1"	-	415,00		
JSWM 3CM	JSW 3CM	1,1	50-20	10-120	1 1/4" / 1"	380,00	392,00		
JSWM 3BM	JSW 3BM	1,5	58-30	10-120	1 1/4" / 1"	404,00	404,00		
-	JSW 3AM	2,2	70-40	10-120	1 1/4" / 1"	-	415,00		
JSWM 3CL	JSW 3CL	1,1	40-15	10-160	1 1/4" / 1"	380,00	392,00		
JSWM 3BL	JSW 3BL	1,5	48-22	10-160	1 1/4" / 1"	404,00	404,00		
-	JSW 3AL	2,2	60-35	10-160	1 1/4" / 1"	-	415,00		
JDWM1AX/30-4	-	0,75	50-20	2-24	1"	224,00	-		
JDWM2A/30- 4"	-	1,1	75-30	2-28	1"	332,00	-		
CPM 100	CP 100	0,25	15-7	10-60	1"	129,00	148,00		
CPM 130	CP 130	0,37	22-14	10-80	1"	141,00	158,00		
CPM 132	CP 132	0,60	22-9	20-120	1"	160,00	178,00		
CPM 150	CP 150	0,75	29-15	20-120	1"	184,00	202,00		
CPM 158	CP 158	0,75	34-25	10-90	1"	184,00	202,00		
CPM 170	CP 170	1,1	38-22	30-120	1 1/4" / 1"	316,00	327,00		
CPM 170M	CP 170M	1,1	35-19	30-160	1 1/4" / 1"	327,00	339,00		

Vandens siurbliai PEDROLLO



Markė 230 V	Markė 400 V	P, kW	H, m	Q, l/min	Pajungimai	Kaina 230 V	Kaina 400 V		
CPM 190	CP 190	1,5	46-26	30-140	1 1/4" / 1"	392,00	392,00		
-	CP 200	2,2	55-36	30-150	1 1/4" / 1"	-	415,00		
CPM 160C	CP 160C	1,1	31-20	20-200	1 1/2" / 1"	366,00	379,00		
CPM 160B	CP 160B	1,5	36-23	20-220	1 1/2" / 1"	392,00	392,00		
-	CP 160A	2,2	42-26	50-240	1 1/2" / 1"	-	405,00		
CPM 210C	CP 210C	2,2	45,5-27	50-250	1 1/2" / 1"	653,00	650,00		
-	CP 210B	3	53-34	50-270	1 1/2" / 1"	-	686,00		
-	CP 210A	4	59,5-39	20-280	1 1/2" / 1"	-	722,00		
CPM 220C	CP 220C	2,2	31-21	50-450	2"	665,00	511,00		
-	CP 220B	3	37-25	50-450	2"	-	606,00		
-	CP 220A	4	48-36	50-450	2"	-	737,00		
-	CP 220AH	5,5	51-42	100-850	2"	-	783,00		
-	CP 230C	3	29-9	100-900	2"	-	606,00		
-	CP 230B	4	38-13	100-900	2"	-	737,00		
-	CP 230A	5,5	45-15	100-900	2"	-	783,00		
-	CP 250B	7,5	60-26,5	100-900	2"	-	1020,0		
-	CP250A	11	77,5-42	100-900	2"	-	1648,0		
HFM 50B	HF 50B	0,37	10-4	50-300	1 1/2"	178,00	196,00		
HFM 50A	HF 50A	0,55	12-6	50-300	1 1/2"	191,00	208,00		
HFM 51B	HF 51B	0,6	17,2-5,4	50-300	1 1/2"	214,00	232,00		
HFM 51A	HF 51A	0,75	20,2-8,4	50-300	1 1/2"	220,00	237,00		
HFM 70C	HF 70C	1,1	28-15	50-300	1 1/2"	349,00	363,00		
HFM 70B	HF 70B	1,5	32-19	50-300	1 1/2"	368,00	368,00		
-	HF 70A	2,2	38-25	50-300	1 1/2"	-	383,00		
HFM 5C	HF 5C	0,6	12-6,5	100-400	2"	220,00	237,00		
HFM 5B	HF 5B	0,75	13-5	100-500	2"	226,00	243,00		
HFM 5A	HF 5A	1,1	14-3	100-600	2"	237,00	250,00		
HFM 5BM	HF 5BM	1,1	18,5-6	100-600	2"	339,00	349,00		
HFM 5AM	HF 5AM	1,5	21,5-10	100-600	2"	355,00	355,00		
HFM 4	HF 4	0,75	9,3-3	200-800	2 1/2"	243,00	262,00		
HFM 6C	HF 6C	1,1	11,7-3	200-1000	3"	392,00	404,00		
HFM 6B	HF 6B	1,5	14,5-5	200-1100	3"	415,00	415,00		
-	HF 6A	2,2	18,1-6	200-1200	3"	-	434,00		
-	HF 8B	3	21-9	200-1200	4"	-	671,00		
-	HF 8A	4	24-13	200-1200	4"	-	723,00		
-	HF 20B	3	19-8	400-1600	4"	-	671,00		
-	HF 20A	4	21,5-6	400-1800	4"	-	723,00		
-	HF 30B	5,5	18-13	600-2000	4"	-	890,00		
-	HF 30A	7,5	23-18	600-2200	4"	-	936,00		
NGAM 1B	NGA 1B	0,55	17-8	50-300	1 1/2"	237,00	255,00		
NGAM 1A	NGA 1A	0,75	19,5-6	50-350	1 1/2"	243,00	262,00		
NGAM 1B-PRO	NGA 1B-PRO	0,55	17-8	50-300	1 1/2"	499,00	516,00		
NGAM 1A-PRO	NGA 1A-PRO	0,75	19,5-6	50-350	1 1/2"	511,00	527,00		
2CPM 25/130N	2CP 25/130N	0,75	39-15	20-100	1 1/4" / 1"	262,00	279,00		
2CPM 25/14B	2CP 25/14B	1,1	52-22	20-100	1 1/4" / 1"	380,00	392,00		
2CPM 25/14A	2CP 25/14A	1,5	65-32	20-110	1 1/4" / 1"	445,00	457,00		
2CPM 25/16C	2CP 25/16C	1,1	46-24	20-120	1 1/4" / 1"	422,00	430,00		
2CPM 25/16B	2CP 25/16B	1,5	56-30	20-140	1 1/4" / 1"	457,00	457,00		
-	2CP 25/16A	2,2	67-32	20-160	1 1/4" / 1"	-	464,00		
-	2CP 32/200C	3	66,5-36	40-250	1 1/2" / 1 1/4"	-	807,00		
-	2CP 32/200B	4	81-49	40-250	1 1/2" / 1 1/4"	-	837,00		
-	2CP 32/210B	5,5	94-56	40-250	2" / 1 1/4"	-	955,00		
-	2CP 32/210A	7,5	111-74	40-250	2" / 1 1/4"	-	1008,0		
-	2CP 40/180C	4	62-35	100-350	2" / 1 1/2"	-	925,00		
-	2CP 40/180B	5,5	73-46	100-400	2" / 1 1/2"	-	960,00		
-	2CP 40/180A	7,5	85-60	100-400	2" / 1 1/2"	-	1009,0		
-	2CP 40/200B	9,2	94-61	100-450	2" / 1 1/2"	-	1692,0		
-	2CP 40/200A	11	102-69	100-450	2" / 1 1/2"	-	1720,0		

Vandens siurbliai PEDROLLO

Markė 230 V	Markė 400 V	P, kW	H, m	Q, l/min	Pajungimai	Kaina 230 V	Kaina 400 V	
CKM 50	CK 50	0,37	31-5	5-40	3/4"	177,00	196,00	
CKM 80	CK 80	0,55	46-10	5-50	1"	214,00	232,00	
CKM 90	CK 90	0,75	49-13	5-50	1"	220,00	237,00	
CKM 50-BP	CK 50-BP	0,25	20-5	5-40	3/4"	196,00	214,00	
CKRM 80	CKR 80	0,55	46-10	5-50	1"	262,00	279,00	
CKRM 90	CKR 90	0,75	49-13	5-50	1"	273,00	291,00	
2CPM 80	2CP 80	0,37	26-5	5-70	1"	160,00	178,00	
3CPM 60	3CP 80	0,37	30-7	5-70	1"	172,00	191,00	
3CPM 80	3CP 80	0,45	38-5	5-80	1"	172,00	191,00	
4CPM 80	4CP 80	0,60	50-10	5-80	1"	191,00	208,00	
3CPM 100	3CP 100	0,60	37-5	5-120	1"	191,00	208,00	
4CPM 100	4CP 100	0,75	50-5	5-130	1"	220,00	237,00	

Horizontalūs daugiapakopiai vandens siurbiai PEDROLLO



Nerūdyjančio plieno AISI 304 darbo ratai

Markė 230 V	Markė 400 V	P, kW	H, m	Q, l/min	Pajungimai	Kaina 230 V	Kaina 400 V	
PLURIJET M5/90	PLURIJET 5/90	1,1	78-38	5-80	1 1/4" / 1"	594,00	604,00	
PLURIJET M6/90	PLURIJET 6/90	1,5	94-45	5-80	1 1/4" / 1"	638,00	638,00	
PLURIJET M3/130	PLURIJET 3/130	1,1	49-24	5-130	1 1/4" / 1"	525,00	535,00	
PLURIJET M4/130	PLURIJET 4/130	1,5	65-31	5-130	1 1/4" / 1"	572,00	572,00	
PLURIJET M5/130	PLURIJET 5/130	1,8	81-39	5-130	1 1/4" / 1"	1009,00	628,00	
—	PLURIJET 6/130	2,2	97-46	5-130	1 1/4" / 1"	-	663,00	
PLURIJET M3/200	PLURIJET 3/200	1,1	43-13	20-200	1 1/4" / 1"	525,00	535,00	
PLURIJET M4/200	PLURIJET 4/200	1,5	57-17	20-200	1 1/4" / 1"	572,00	572,00	
PLURIJET M5/200	PLURIJET 5/200	1,8	71-22	20-200	1 1/4" / 1"	628,00	628,00	
—	PLURIJET 6/200	2,2	85-26	20-200	1 1/4" / 1"	-	663,00	
5CRM 90	5CR 90	1,1	78-38	5-90	1 1/4" / 1"	586,00	597,00	
6CRM 90	6CR 90	1,5	94-45	5-90	1 1/4" / 1"	632,00	632,00	
7CRM 90	7CR 90	1,8	110-53	5-90	1 1/4" / 1"	589,00	589,00	
3CRM 130	3CR 130	1,1	49-24	5-130	1 1/4" / 1"	519,00	530,00	
4CRM 130	4CR 130	1,5	65-31	5-130	1 1/4" / 1"	564,00	564,00	
5CRM 130	5CR 130	1,8	81-39	5-130	1 1/4" / 1"	620,00	620,00	
-	6CR 130	2,2	97-46	5-130	1 1/4" / 1"	-	657,00	
3CRM 200	3CR 200	1,1	43-13	20-200	1 1/4" / 1"	519,00	530,00	
4CRM 200	4CR 200	1,5	57-17	20-200	1 1/4" / 1"	564,00	564,00	
5CRM 200	5CR 200	1,8	71-22	20-200	1 1/4" / 1"	620,00	620,00	
-	6CR200	2,2	85-26	20-200	1 1/4" / 1"	-	657,00	

Darbo ratai iš technopolimero

Markė 230 V	Markė 400 V	P, kW	H, m	Q, l/min	Pajungimai	Kaina 230 V	Kaina 400 V	
2CRM 80	2CR 80	0,37	26-5	5-70	1"	177,00	186,00	
3CRM 60	3CR 60	0,37	30-7	5-70	1"	182,00	195,00	
3CRM 80	3CR 80	0,45	38-5	5-80	1"	190,00	202,00	
4CRM 80	4CR 80	0,6	50-10	5-80	1"	202,00	220,00	
5CRM 80	5CR 80	0,75	66-12	5-80	1"	246,00	260,00	
3CRM 100	3CR 100	0,6	37-5	5-120	1"	202,00	220,00	
4CRM 100	4CR 100	0,75	50-5	5-130	1"	246,00	260,00	
5CRM 100	5CR 100	1,1	62-8	5-130	1"	272,00	283,00	
PLURIJET M3/60X	PLURIJET 3/60X	0,37	30-7	5-70	1"	190,00	201,00	
PLURIJET M3/80X	PLURIJET 3/80X	0,48	38-5	5-80	1"	195,00	206,00	
PLURIJET M4/80X	PLURIJET 4/80X	0,55	50-10	5-80	1"	206,00	217,00	
PLURIJET M3/100X	PLURIJET 3/100X	0,55	37-5	5-120	1"	206,00	217,00	
PLURIJET M4/100X	PLURIJET 4/100X	0,75	50-5	5-130	1"	252,00	266,00	
PLURIJET M5/90X	PLURIJET 5/90X	1,1	76-33	5-80	1 1/4" / 1"	522,00	535,00	
PLURIJET M6/90X	PLURIJET 6/90X	1,5	93-43	5-80	1 1/4" / 1"	568,00	568,00	
PLURIJET M3/130X	PLURIJET 3/130X	1,1	49-24	5-130	1 1/4" / 1"	488,00	500,00	
PLURIJET M4/130X	PLURIJET 4/130X	1,5	65-31	5-130	1 1/4" / 1"	514,00	514,00	
—	PLURIJET 5/130X	1,8	81-39	5-130	1 1/4" / 1"	-	546,00	
—	PLURIJET 6/130X	2,2	97-46	5-130	1 1/4" / 1"	-	579,00	
PLURIJET M3/200X	PLURIJET 3/200X	1,1	43-13	20-200	1 1/4" / 1"	488,00	500,00	
PLURIJET M4/200X	PLURIJET 4/200X	1,5	57-17	20-200	1 1/4" / 1"	512,00	514,00	
—	PLURIJET 5/200X	1,8	72-22	20-200	1 1/4" / 1"	-	546,00	
—	PLURIJET 6/200X	2,2	86-26	20-200	1 1/4" / 1"	-	579,00	
5CRM 90X	5CR 90X	1,1	78-38	5-90	1 1/4" / 1"	534,00	545,00	
6CRM 90X	6CR 90X	1,5	94-45	5-90	1 1/4" / 1"	570,00	570,00	
3CRM 130X	3CR 130X	1,1	49-24	5-130	1 1/4" / 1"	488,00	498,00	
4CRM 130X	4CR 130X	1,5	65-31	5-130	1 1/4" / 1"	502,00	502,00	
-	5CR 130X	1,8	81-39	5-130	1 1/4" / 1"	-	551,00	
-	6CR 130X	2,2	97,46	5-130	1 1/4" / 1"	-	593,00	
3CRM 200X	3CR 200X	1,1	43-13	20-200	1 1/4" / 1"	488,00	498,00	
4CRM 200X	4CR 200X	1,5	57-17	20-200	1 1/4" / 1"	502,00	502,00	
-	5CR 200X	1,8	71-22	20-200	1 1/4" / 1"	-	551,00	
-	6SR 200X	2,2	85-26	20-200	1 1/4" / 1"	-	593,00	



Vertikalūs vandens siurbliai PEDROLLO

Markė 230 V	Markė 400 V	P, kW	H, m	Q, l/min	Pajungimai	Kaina 230 V	Kaina 400 V	
MKM 3/3	MK 3/3	0,75	50-28	10-80	1 1/4" / 1"	489,00	500,00	
MKM 3/4	MK 3/4	1,1	67-38	10-80	1 1/4" / 1"	512,00	522,00	
MKM 3/5	MK 3/5	1,1	83-47	10-80	1 1/4" / 1"	527,00	540,00	
MKM 3/6	MK 3/6	1,5	100-56	10-80	1 1/4" / 1"	557,00	557,00	
MKM 5/4	MK 5/4	1,1	55-20	20-120	1 1/4" / 1"	512,00	522,00	
MKM 5/5	MK 5/5	1,1	69-25	20-120	1 1/4" / 1"	527,00	540,00	
MKM 5/6	MK 5/6	1,5	83-30	20-120	1 1/4" / 1"	557,00	557,00	
MKM 5/7	MK 5/7	1,8	96-34	20-120	1 1/4" / 1"	579,00	579,00	
MKM 5/8	MK 5/8	2,2	110-40	20-120	1 1/4" / 1"	630,00	590,00	
MKM 8/4	MK 8/4	1,5	54-15	40-180	1 1/4" / 1"	535,00	535,00	
MKM 8/5	MK 8/5	1,8	67,5-18	40-180	1 1/4" / 1"	557,00	557,00	
MKM 8/6	MK 8/6	2,2	82-20	40-180	1 1/4" / 1"	608,00	568,00	

Vandens siurbliai PEDROLLO su AISI 304 ner. plieno hidrauline dalimi

Markė 230 V	Markė 400 V	P, kW	H, m	Q, l/min	Pajungimai	Kaina 230 V	Kaina 400 V	
CPM 100-ST4	CP 100-ST4	0,25	15-6,5	10-90	1 1/4" / 1"	204,00	219,00	
CPM 130-ST4	CP 130-ST4	0,37	21,5-9	10-100	1 1/4" / 1"	214,00	231,00	
CPM 132-ST4	CP 132-ST4	0,55	23-12	20-120	1 1/4" / 1"	226,00	242,00	
CPM 150-ST4	CP 150-ST4	0,75	31-14	20-150	1 1/4" / 1"	249,00	260,00	
CPM 158-ST4	CP 158-ST4	0,75	35,5-19	10-120	1 1/4" / 1"	249,00	260,00	
CPM 170-ST4	CP 170-ST4	1,1	40-20	10-140	1 1/4" / 1"	340,00	350,00	
CPM 170M-ST4	CP 170M-ST4	1,1	35,5-19	20-160	1 1/4" / 1"	345,00	355,00	
CPM 180-ST4	CP 180-ST4	1,1	30-13	40-230	1 1/4" / 1"	350,00	361,00	
CPM 190-ST4	CP 190-ST4	1,5	35-16	40-250	1 1/4" / 1"	367,00	367,00	
CTM 200-ST4	CT 200-ST4	2,2	42-20	40-270	1 1/4" / 1"	392,00	392,00	

Vandens siurbliai PEDROLLO su AISI 316L ner. plieno hidrauline dalimi

Markė 230 V	Markė 400 V	P, kW	H, m	Q, l/min	Pajungimai	Kaina 230 V	Kaina 400 V		
CPM 100-ST6	CP 100-ST6	0,25	15-6,5	10-90	1 1/4" / 1"	237,00	253,00		
CPM 130-ST6	CP 130-ST6	0,37	21,5-9	10-100	1 1/4" / 1"	248,00	264,00		
CPM 132-ST6	CP 132-ST6	0,55	23-12	20-120	1 1/4" / 1"	260,00	276,00		
CPM 150-ST6	CP 150-ST6	0,75	31-14	20-150	1 1/4" / 1"	318,00	329,00		
CPM 158-ST6	CP 158-ST6	0,75	35,5-19	10-120	1 1/4" / 1"	318,00	329,00		
CPM 170-ST6	CP 170-ST6	1,1	40-20	10-140	1 1/4" / 1"	415,00	426,00		
CPM 170M-ST6	CP 170M-ST6	1,1	35,5-19	20-160	1 1/4" / 1"	421,00	431,00		
CPM 180-ST6	CP 180-ST6	1,1	30-13	40-230	1 1/4" / 1"	421,00	431,00		
CPM 190-ST6	CP 190-ST6	1,5	35-16	40-250	1 1/4" / 1"	438,00	438,00		
CTM 200-ST6	CT 200-ST6	2,2	42-20	40-270	1 1/4" / 1"	469,00	469,00		
AL-REDM 135	AL-RED 135	0,75	21-10	20-160	1 1/4" / 1"	249,00	267,00		

Konsoliniai vandens siurbiai PEDROLLO 50Hz, n=2900 aps/min



Markė 230 V	Markė 400 V	P, kW	H, m	Q, l/min	Pajungimai	Kaina 230 V	Kaina 400 V
FM 32/160C	F 32/160C	1,5	24-13	100-350	50 / 32	661,00	636,00
FM 32/160B	F 32/160B	2,2	30-16	100-400	50 / 32	834,00	661,00
—	F 32/160A	3	37-20	100-450	50 / 32	—	757,00
—	F 32/200C	4	44-31,5	100-450	50 / 32	—	861,00
—	F 32/200B	5,5	52-36	100-500	50 / 32	—	909,00
—	F 32/200A	7,5	57-44	100-500	50 / 32	—	971,00
—	F 32/200BH	3	45-28	100-300	50 / 32	—	835,00
—	F 32/200AH	4	55-38	100-300	50 / 32	—	860,00
—	F 32/250C	9,2	75-55	100-400	50 / 32	—	1777,00
—	F 32/250B	11	87-62	100-450	50 / 32	—	1799,00
—	F 32/250A	15	97-70	100-480	50 / 32	—	1908,00
FM 40/125C	F 40/125C	1,1	16-6	100-550	65 / 40	587,00	600,00
FM 40/125B	F 40/125B	1,5	20,5-9	100-600	65 / 40	624,00	624,00
—	F 40/125A	2,2	26-10	100-700	65 / 40	—	649,00
FM 40/160C	F 40/160C	2,2	27-14	100-600	65 / 40	834,00	661,00
—	F 40/160B	3	32-20	100-600	65 / 40	—	758,00
—	F 40/160A	4	38-20	100-700	65 / 40	—	812,00
—	F 40/200B	5,5	47-24	100-700	65 / 40	—	971,00
—	F 40/200A	7,5	54-32	100-700	65 / 40	—	1022,00
—	F 40/250C	9,2	64-47	100-700	65 / 40	—	1854,00
—	F 40/250B	11	71-55	100-700	65 / 40	—	1816,00
—	F 40/250A	15	88-72	100-700	65 / 40	—	1993,00
FM 50/125C	F 50/125C	2,2	17,5-6	300-1200	65 / 50	835,00	661,00
—	F 50/125B	3	20,7-9	300-1200	65 / 50	—	758,00
—	F 50/125A	4	23,5-13	300-1200	65 / 50	—	813,00
—	F 50/160C	4	27-16	300-1000	65 / 50	—	861,00
—	F 50/160B	5,5	32-21	300-1100	65 / 50	—	909,00
—	F 50/160A	7,5	37-27	300-1100	65 / 50	—	971,00
—	F 50/200C	11	46-33	400-1600	65 / 50	—	1854,00
—	F 50/200B	15	54-38	400-1700	65 / 50	—	1993,00
—	F 50/200A	18,5	63-45	400-1800	65 / 50	—	2117,00
—	F 50/200AR	22	69-53	400-1800	65 / 50	—	2266,00
—	F 50/250D	9,2	51-32	300-900	65 / 50	—	1856,00
—	F 50/250C	11	59-42	300-900	65 / 50	—	1910,00
—	F 50/250B	15	72-59	300-1000	65 / 50	—	1993,00
—	F 50/250A	18,5	85-73	300-1000	65 / 50	—	2117,00
—	F 50/250AR	22	95-83	300-1000	65 / 50	—	2266,00
—	F 65/125C	4	16-11	600-1800	80 / 65	—	971,00
—	F 65/125B	5,5	18-13	600-2000	80 / 65	—	1021,00
—	F 65/125A	7,5	23-18	600-2200	80 / 65	—	1067,00
—	F 65/160C	9,2	32-22	600-2200	80 / 65	—	1854,00
—	F 65/160B	11	36,5-23	600-2400	80 / 65	—	1866,00
—	F 65/160A	15	40,5-28	600-2400	80 / 65	—	1992,00
—	F 65/200B	15	46-35,5	400-2000	80 / 65	—	2029,00
—	F 65/200A	18,5	52-40	400-2100	80 / 65	—	2153,00
—	F 65/200AR	22	57-46	400-2100	80 / 65	—	2291,00
—	F 65/250C	30	76-53	400-2350	80 / 65	—	5115,00
—	F 65/250B	37	87-62	400-2500	80 / 65	—	5524,00
—	F 65/250A	45	95-68	400-2600	80 / 65	—	5681,00
—	F 80/160D	11	25-13	500-4000	100 / 80	—	1906,00
—	F 80/160C	15	30-18	500-4000	100 / 80	—	2029,00
—	F 80/160B	18,5	35-23	500-4000	100 / 80	—	2153,00
—	F 80/160A	22	40-28	500-4000	100 / 80	—	2291,00
—	F 80/200B	30	56-34,5	500-3900	100 / 80	—	5677,00
—	F 80/200A	37	62-40	500-3900	100 / 80	—	5926,00
—	F 80/250B	45	77-54	600-3900	100 / 80	—	5990,00
—	F 80/250A	55	88,5-60	600-3900	100 / 80	—	11602,00



Konsoliniai vandens siurbliai PEDROLLO 50Hz, n=2900 aps/min



Markė 230 V	Markė 400 V	P, kW	H, m	Q, l/min	Pajungimai	Kaina 230 V	Kaina 400 V
—	F 100/160C	15	28,5-11	1000-5000	125 / 100	—	2153,00
—	F 100/160B	18,5	32,5-11	1000-5500	125 / 100	—	2266,00
—	F 100/160A	22	37-13	1000-6000	125 / 100	—	2390,00
—	F 100/200C	30	51-28	833-4650	125 / 100	—	5800,00
—	F 100/200B	37	57-33	833-4900	125 / 100	—	6162,00
—	F 100/200A	45	63-38	833-5250	125 / 100	—	6224,00
—	F 100/250B	55	75-48	800-5150	125 / 100	—	11923,00
—	F 100/250A	75	89-58	800-5750	125 / 100	—	12199,00



F markės siurbliai atitinka EN 733 – DIN 24255 reikalavimus. **GARANTIJA SIURBLIAMS – 24 MĖNESIAI.**

Konsoliniai vandens siurbliai PEDROLLO 50Hz, n=1450 aps/min

Markė 400 V	P, kW	H, m	Q, l/min	Pajungimai	Kaina
F4 32/160B	0.37	7.5-4.5	50-200	50 / 32	606,00
F4 32/160A	0.37	9-5	50-225	50 / 32	606,00
F4 32/200B	0.75	12.5-9	50-250	50 / 32	788,00
F4 32/200A	1.1	14-10.5	20-250	50 / 32	812,00
F4 32/200BH	0.75	11.3-9.2	50-150	50 / 32	829,00
F4 32/200AH	0.75	13.8-11	50-160	50 / 32	829,00
F4 32/250C	1.1	18.5-13.5	50-200	50 / 32	1187,00
F4 32/250B	1.5	21.5-15.5	50-225	50 / 32	1214,00
F4 32/250A	2.2	24-16.5	50-250	50 / 32	1232,00
F4 40/160B	0.37	7.5-3.5	50-320	65 / 40	608,00
F4 40/160A	0.55	9-4.5	50-350	65 / 40	636,00
F4 40/200B	0.75	11.5-7	50-350	65 / 40	835,00
F4 40/200A	1.1	13.8-10	50-350	65 / 40	862,00
F4 40/250C	1.1	15.5-10	50-400	65 / 40	1187,00
F4 40/250B	1.5	17.5-12	50-400	65 / 40	1214,00
F4 40/250A	2.2	22-17	50-400	65 / 40	1232,00
F4 50/125B	0.55	5-2	150-600	65 / 50	642,00
F4 50/125A	0.55	6-3	150-600	65 / 50	642,00
F4 50/160B	0.75	8-3.8	150-650	65 / 50	835,00
F4 50/160A	1.1	9.3-4.5	150-700	65 / 50	846,00
F4 50/200C	1.5	11-7.5	200-850	65 / 50	1187,00
F4 50/200B	2.2	13-9.5	200-850	65 / 50	1214,00
F4 50/200A	2.2	15-11.2	200-900	65 / 50	1232,00
F4 50/200AR	3.0	17-13.2	200-900	65 / 50	1261,00
F4 50/250D	1.1	12.5-5	150-650	65 / 50	1173,00
F4 50/250C	1.5	14-5	150-700	65 / 50	1196,00
F4 50/250B	2.2	18-10.5	150-700	65 / 50	1243,00
F4 50/250A	2.2	20-13	150-700	65 / 50	1243,00
F4 50/250AR	3.0	23.5-17	150-700	65 / 50	1272,00
F4 65/125B	0.75	4.7-3	300-1100	80 / 65	920,00
F4 65/125A	10.1	5.7-4	300-1200	80 / 65	944,00
F4 65/160C	1.1	8-5.5	300-1100	80 / 65	1062,00
F4 65/160B	1.5	9.1-5.7	300-1200	80 / 65	1089,00
F4 65/160A	2.2	10.1-7	300-1200	80 / 65	1117,00
F4 65/200A	2.2	12-8.5	300-1250	80 / 65	1172,00
F4 65/200AR	3.0	14-10	300-1300	80 / 65	1265,00
F4 65/250B	4.0	21.8-15.5	200-1250	80 / 65	2069,00
F4 65/250A	5.5	23.5-17	200-1300	80 / 65	2096,00



Konsoliniai vandens siurbliai PEDROLLO 50Hz, n=1450 aps/min

... the spring of life

Markė 400 V	P, kW	H, m	Q, l/min	Pajungimai	Kaina
F4 80/160D	1.5	6.3-2.5	300-2000	100 / 80	1146,00
F4 80/160C	2.2	7.5-3.8	300-2000	100 / 80	1197,00
F4 80/160B	2.2	8.8-5	300-2000	100 / 80	1197,00
F4 80/160A	3.0	10-6.2	300-2000	100 / 80	1221,00
F4 80/200B	4.0	14-9	300-1800	100 / 80	1865,00
F4 80/200A	5.5	15.5-10.5	300-1900	100 / 80	1997,00
F4 80/250B	5.5	19.5-13.5	300-1800	100 / 80	2442,00
F4 80/250A	7.5	22-15	30-1950	100 / 80	2466,00
F4 100/160B	2.2	8.1-2.7	400-2750	125 / 100	1260,00
F4 100/160A	3.0	9.2-3.2	400-3000	125 / 100	1283,00
F4 100/200C	4.0	12.7-7	400-2300	125 / 100	2234,00
F4 100/200B	5.5	14.2-8.5	400-2400	125 / 100	2283,00
F4 100/200A	5.5	15.8-9.5	400-2600	125 / 100	2283,00
F4 100/250B	7.5	18.5-11.5	400-2600	125 / 100	2907,00
F4 100/250A	9.2	22-13.5	400-2900	125 / 100	2942,00



F markės siurbliai atitinka EN 733 – DIN 24255 reikalavimus. **GARANTIJA SIURBLIAMS – 24 MĖNESIAI.**

Konsoliniai nerūdijančio plieno vandens siurbliai PEDROLLO F-INOX

Markė 400 V	P, kW	H, m	Q, l/min	Pajungimai	Kaina 400 V
F 50/160C-I	4	27-16	300-1000	65 / 50	3054,00
F 50/160B-I	5,5	32-21	300-1100	65 / 50	3105,00
F 50/160A-I	7,5	37-27	300-1100	65 / 50	3152,00
F 65/125C-I	4	16-11	600-1800	80 / 65	3626,00
F 65/125B-I	5,5	18-13	600-2000	80 / 65	3682,00
F 65/125A-I	7,5	23-18	600-2200	80 / 65	3713,00



hidraulinė dalis - nerūdijančio plieno AISI 316

Flanšai konsoliniams siurbliams F, F4

Kodas	Siurbliams	DN1	DN2	Kaina
ASS14FL0320	F32, F4 32	50 / 2"	32 / 1 1/4"	46,00
ASS14FL0400	F40, F4 40	65 / 2 1/2"	40 / 1 1/2"	52,00
ASS14FL0500	F50, F4 50	65 / 2 1/2"	50 / 2"	55,00
ASS14FL0650	F65, F4 65	80 / 3"	65 / 2 1/2"	59,00
ASS14FL0800	F80, F4 80	100 / 4"	80 / 3"	71,00
ASS14FL1000	F100, F4 100	125 / 5"	100 / 4"	88,00



Giluminiai siurbliai šuliniams PEDROLLO



Markė	Pastaba	Galia, kW	H, m	Q, m ³ /val	Kaina, Eur su PVM
UPm 2/4 - GE	Su plūde ir 10 m kabeliu	0,75	31-61	4,8-0,6	400,00
NKm 2/4- GE	Su plūde ir 10 m kabeliu	0,75	31-61	4,8-0,6	433,00
NKm 2/5- GE	Su plūde ir 10 m kabeliu	1,1	40-79	4,8-0,6	467,00
NKM 2/6-GE	Su plūde ir 10 m kabeliu	1,5	48-93	4,8-0,6	480,00
NKM 4/4-GE	Su plūde ir 10 m kabeliu	0,75	16-52	7,2-1,2	433,00
NKM 4/5-GE	Su plūde ir 10 m kabeliu	1,1	20-65	7,2-1,2	467,00
NKM 4/6-GE	Su plūde ir 10 m kabeliu	1,5	24-78	7,2-1,2	480,00
NKM 8/3-GE	Su plūde ir 10 m kabeliu	1,1	16-39	9,6-2,4	467,00
NKM 8/4-GE	Su plūde ir 10 m kabeliu	1,5	21-51	9,6-2,4	480,00
SUMO M2/11	Su plūde ir 20 m kabeliu	1,1	30-72	4,8-0,6	453,00
TOP MULTI 2	Su plūde ir 10 m kabeliu	0,55	5 - 40	4,8-0,6	250,00
TOP MULTI 3	Su plūde ir 10 m kabeliu	0,75	4 - 32	7,2-0,6	274,00
TOP MULTI 4	Su plūde ir 10 m kabeliu	0,75	6 - 50	4,8-0,6	339,00
TOP MULTI-TECH 2	Automatinis, su 10 m kabelio	0,55	5 - 40	4,8-0,6	340,00
TOP MULTI-TECH 3	Automatinis, su 10 m kabelio	0,55	4 - 32	7,2-0,6	396,00
TOP MULTI 2-EVO	Su plūde ir 10 m kabeliu	0,55	5 - 40	4,8-0,6	309,00
TOP MULTI 3-EVO	Su plūde ir 10 m kabeliu	0,55	4 - 32	7,2-0,6	328,00
TOP MULTI-EVOTECH 2	Automatinis, su 10 m kabelio	0,55	5 - 40	4,8-0,6	393,00
TOP MULTI-EVOTECH 3	Automatinis, su 10 m kabelio	0,55	4 - 32	7,2-0,6	418,00



GARANTIJA SIURBLIAMS – 24 MĖNESIAI.

Laikiklis horizontaliam siurblio UP-NK pajungimui

Kodas	Kaina, Eur
ASSKITUPFO	82,00



Siurblio pasiurbimo komplektas su plūduru

Kodas	Modelis	Pajungimo diam.	Kaina, Eur
ASSKITKGE	KGE	1 1/4"	67,00

Žarnos ilgis - 1,5 m.

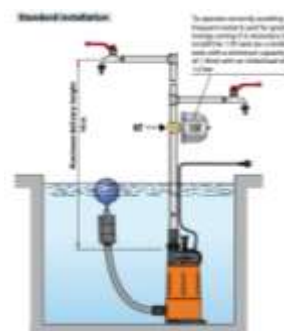

Išsiplėtimo indas 1L

Kodas	Modelis	Pajungimo diam.	Kaina, Eur
500667	1SF	1/2"	33,00



4" PEDROLLO siurbliai grežiniams su plaukiojančiais darbo ratais



(Atitinka EU 547/2012, MEI ≥ 0,40)

Markė 230 V	Markė 400 V	Q, m ³ /val	H, m	P, kW	Kaina FRANKLIN, Eur su PVM		Kaina PEDROLLO, Eur su PVM	
					230 V	400 V	230 V	400 V
4SR1M/12F	4SR1/12F	0,3-1,8 (1,2)	71-30 (52)	0.37	487,00	497,00	372,00	432,00
4SR1M/17F	4SR1/17F	0,3-1,8 (1,2)	100-42,5 (74)	0.55	557,00	557,00	487,00	473,00
4SR1M/22F	4SR1/22F	0,3-1,8 (1,2)	130-55 (96)	0.75	642,00	642,00	565,00	560,00
4SR1M/32F	4SR1/32F	0,3-1,8 (1,2)	188-80 (139)	1.1	847,00	847,00	752,00	737,00
4SR1M/42F	4SR1/42F	0,3-1,8 (1,2)	247-105 (183)	1.5	1027,00	1010,00	917,00	885,00
4SR1.5M/7F	4SR1.5/7F	0,3-2,7 (1,5)	50-18 (40)	0.37	500,00	500,00	397,00	401,00
4SR1.5M/11F	4SR1.5/11F	0,3-2,7 (1,5)	78-28 (62,5)	0.55	506,00	517,00	447,00	456,00
4SR1.5M/15F	4SR1.5/15F	0,3-2,7 (1,5)	105-37 (85)	0.75	574,00	574,00	508,00	508,00
4SR1.5M/22F	4SR1.5/22F	0,3-2,7 (1,5)	151-46 (122)	1.1	746,00	746,00	658,00	658,00
4SR1.5M/30F	4SR1.5/30F	0,3-2,7 (1,5)	202-63 (164)	1.5	865,00	835,00	765,00	732,00
4SR2M/6F	4SR2/6F	0,6-3,9 (2,4)	45-13 (33)	0.37	469,00	469,00	380,00	403,00
4SR2M/9F	4SR2/9F	0,6-3,9 (2,4)	67-19,5 (49,5)	0.55	496,00	506,00	370,00	421,00
4SR2M/12F	4SR2/12F	0,6-3,9 (2,4)	90-25,7 (66,2)	0.75	522,00	533,00	408,00	454,00
4SR2M/17F	4SR2/17F	0,6-3,9 (2,4)	127-36,4 (94)	1.1	621,00	633,00	535,00	534,00
4SR2M/23F	4SR2/23F	0,6-3,9 (2,4)	172-49 (127)	1.5	863,00	798,00	711,00	677,00
4SR2M/33F	4SR2/33F	0,6-3,9 (2,4)	246-71 (182)	2.2	—	929,00	865,00	815,00
4SR4M/6F	4SR4/6F	1,2-6,0 (4,2)	45,5-17 (33)	0.55	516,00	516,00	437,00	426,00
4SR4M/8F	4SR4/8F	1,2-6,0 (4,2)	60,5-22,5 (44)	0.75	541,00	541,00	465,00	459,00
4SR4M/12F	4SR4/12F	1,2-6,0 (4,2)	91-33,5 (66)	1.1	619,00	631,00	529,00	527,00
4SR4M/15F	4SR4/15F	1,2-6,0 (4,2)	114-42 (83)	1.5	780,00	716,00	637,00	602,00
4SR4M/22F	4SR4/22F	1,2-6,0 (4,2)	167-61,5 (121)	2.2	1159,00	975,00	849,00	774,00
4SR4M/30F	4SR4/30F	1,2-6,0 (4,2)	228-84 (165)	3.0	—	1065,00	—	925,00
4SR6M/4F	4SR6/4F	1,5-9,0 (6,0)	25,5-9,5 (19,8)	0.55	569,00	569,00	482,00	470,00
4SR6M/6F	4SR6/6F	1,5-9,0 (6,0)	38-14,5 (29,5)	0.75	598,00	598,00	513,00	508,00
4SR6M/9F	4SR6/9F	1,5-9,0 (6,0)	57-21,5 (44,5)	1.1	690,00	690,00	585,00	574,00
4SR6M/13F	4SR6/13F	1,5-9,0 (6,0)	83-31,5 (64,5)	1.5	853,00	785,00	695,00	654,00
4SR6M/17F	4SR6/17F	1,5-9,0 (6,0)	108-41 (84)	2.2	1016,00	995,00	861,00	780,00
—	4SR6/24F	1,5-9,0 (6,0)	152-58 (119)	3.0	—	1205,00	—	1120,00
—	4SR6/32F	1,5-9,0 (6,0)	203-77 (159)	4.0	—	1599,00	—	1316,00
4SR8M/4F	4SR8/4F	2,4-12 (8,4)	26-6,5 (19,4)	0.75	585,00	585,00	513,00	492,00
4SR8M/7F	4SR8/7F	2,4-12 (8,4)	46-11,5 (34)	1.1	674,00	674,00	585,00	557,00
4SR8M/9F	4SR8/9F	2,4-12 (8,4)	59-15 (43,5)	1.5	814,00	744,00	654,00	615,00
4SR8M/13F	4SR8/13F	2,4-12 (8,4)	85-21,5 (63)	2.2	1161,00	961,00	850,00	747,00
—	4SR8/17F	2,4-12 (8,4)	111-28 (82)	3.0	—	1142,00	—	1056,00
—	4SR8/24F	2,4-12 (8,4)	151-38 (116)	4.0	—	1510,00	—	1221,00
—	4SR8/32F	2,4-12 (8,4)	203-51 (155)	5.5	—	1765,00	—	1437,00
4SR10M/5-N	4SR10/5-N	3,0-15	29,5-6 (19)	0.75	647,00	617,00	530,00	530,00
4SR10M/7-N	4SR10/7-N	3,0-15	41-8,5 (26)	1.1	769,00	702,00	570,00	570,00
4SR10M/9-N	4SR10/9-N	3,0-15	53-10,5 (34)	1.5	938,00	872,00	659,00	625,00
4SR10M/13-N	4SR10/13-N	3,0-15	77-15,5 (50)	2.2	1164,00	1103,00	810,00	756,00
—	4SR10/18-N	3,0-15	106-21 (70)	3	—	1445,00	—	975,00
—	4SR10/24-N	3,0-15	141-28,5 (93)	4	—	1530,00	—	1320,00
—	4SR10/32-N	3,0-15	189-38 (124)	5.5	—	1820,00	—	1610,00
—	4SR10/43-N	3,0-15	254-51 (166)	7.5	—	2355,00	—	1895,00
4SR12M/5-N	4SR12/5-N	3,0-18	25-5 (16,5)	0.75	644,00	617,00	608,00	608,00
4SR12M/7-N	4SR12/7-N	3,0-18	35-7 (23)	1.1	777,00	709,00	708,00	649,00
4SR12M/9-N	4SR12/9-N	3,0-18	45-9 (30)	1.5	938,00	888,00	802,00	768,00
4SR12M/14-N	4SR12/14-N	3,0-18	70-14 (46)	2.2	1164,00	1087,00	1096,00	1008,00
—	4SR12/19-N	3,0-18	95-19 (63)	3	—	1410,00	—	1288,00
—	4SR12/25-N	3,0-18	125-25 (83)	4	—	1660,00	—	1494,00
—	4SR12/34-N	3,0-18	170-34 (112)	5.5	—	2400,00	—	1971,00
—	4SR12/41-N	3,0-18	197-41 (135)	7.5	—	2710,00	—	2250,00



4" PEDROLLO siurbliai grežiniams su plaukiojančiais darbo ratais



(Atitinka EU 547/2012, MEI ≥ 0,40)

Markė 230 V	Markė 400 V	Q, m ³ /val	H, m	P, kW	Kaina FRANKLIN, Eur su PVM		Kaina PEDROLLO, Eur su PVM	
					230 V	400 V	230 V	400 V
4SR15M/6-N	4SR15/6-N	3,0-20,4	30-3 (17)	1.1	787,00	719,00	717,00	657,00
4SR15M/8-N	4SR15/8-N	3,0-20,4	40-5 (23)	1.5	903,00	872,00	888,00	752,00
4SR15M/12-N	4SR15/12-N	3,0-20,4	60-7 (35)	2.2	1154,00	1060,00	1066,00	981,00
—	4SR15/16-N	3,0-20,4	80-9 (46)	3	—	1384,00	—	1266,00
—	4SR15/21-N	3,0-20,4	105-12 (61)	4	—	1641,00	—	1477,00
—	4SR15/29-N	3,0-20,4	145-17 (85)	5.5	—	2240,00	—	1813,00
—	4SR15/39-N	3,0-20,4	195-23,5 (113)	7.5	—	2630,00	—	2190,00

Pastaba: Darbo kreivių tolerancija atitinka EN ISO 9906 p.3B (Q ±9%, H ±7%)

Stulpelyje Q ir H skliaustuose esantys skaičiai rodo slėgį prie nurodyto našumo.

GARANTIJA: hidraulikoms 4SR1÷4SR4 – 36 mėn., 4SR6÷4SR15 – 24 mėn.; varikliams PEDROLLO 0,37-1,1 Kw 230V -36 mėn., kiti PEDROLLO, SUMOTO – 24 mėn., varikliai FRANKLIN ELECTRIC 0,37÷1,10 kW – 24 mėn., nuo 1,5 kW ir daugiau – 12 mėn.

4" PEDROLLO siurbliai grežiniams su Franklin arba Pedrollo varikliais

Markė 230 V	Markė 400 V	Q, m ³ /val	H, m	P, kW	Kaina FRANKLIN, Eur su PVM		Kaina PEDROLLO, Eur su PVM	
					230 V	400 V	230 V	400 V
4SR10M/5	4SR10/5	3,0-15 (10,5)	27-8 (21)	1.1	654,00	623,00	613,00	615,00
4SR10M/7	4SR10/7	3,0-15 (10,5)	47-14,5 (30)	1.5	783,00	710,00	716,00	655,00
4SR10M/10	4SR10/10	3,0-15 (10,5)	60,5-18,5 (42)	2.2	950,00	885,00	713,00	759,00
—	4SR10/15	3,0-15 (10,5)	87-26,5 (64)	3.0	—	1115,00	—	1035,00
—	4SR10/20	3,0-15 (10,5)	114-35 (85)	4.0	—	1459,00	—	1339,00
—	4SR10/26	3,0-15 (10,5)	161-49 (110)	5.5	—	1830,00	—	1669,00
—	4SR10/35	3,0-15 (10,5)	214-65,5 (148)	7.5	—	2480,00	—	2045,00
4SR12M/4	4SR12/4	3,0-18 (12)	24-8 (16)	1.1	654,00	623,00	613,00	615,00
4SR12M/6	4SR12/6	3,0-18 (12)	37-14 (28)	1.5	783,00	716,00	716,00	655,00
4SR12M/9	4SR12/9	3,0-18 (12)	55-22 (42)	2.2	950,00	896,00	813,00	780,00
—	4SR12/12	3,0-18 (12)	73-29 (56)	3.0	—	1099,00	—	1020,00
—	4SR12/16	3,0-18 (12)	97-38 (75)	4.0	—	1423,00	—	1300,00
—	4SR12/22	3,0-18 (12)	135-53 (103)	5.5	—	1677,00	—	1560,00
—	4SR12/29	3,0-18 (12)	176-71 (135)	7.5	—	2427,00	—	1935,00
4SR15M/5	4SR15/5	3,0-22,5 (15)	30-7,5 (20)	1.5	795,00	726,00	726,00	664,00
4SR15M/7	4SR15/7	3,0-22,5 (15)	42-10 (27)	2.2	912,00	881,00	896,00	759,00
—	4SR15/10	3,0-22,5 (15)	60-15 (38)	3.0	—	1070,00	—	992,00
—	4SR15/13	3,0-22,5 (15)	77-19 (50)	4.0	—	1399,00	—	1210,00
—	4SR15/18	3,0-22,5 (15)	108-27 (71)	5.5	—	1660,00	—	1540,00
—	4SR15/24	3,0-22,5 (15)	145-36 (95)	7.5	—	2265,00	—	1830,00

Pastaba: Darbo kreivių tolerancija atitinka EN ISO 9906 p.3B (Q ±9%, H ±7%)

Stulpelyje Q ir H skliaustuose esantys skaičiai rodo slėgį prie nurodyto našumo.

GARANTIJA: 4SR6÷4SR15 – 24 mėn.; varikliams PEDROLLO 0,37-1,1 Kw 230V -36 mėn., kiti PEDROLLO, SUMOTO – 24 mėn., varikliai FRANKLIN ELECTRIC 0,37÷1,10 kW – 24 mėn., nuo 1,5 kW ir daugiau – 12 mėn.

PEDROLLO giluminiai siurbliai su dvipoliais Franklin varikliais

Markė 230 V	Q, m ³ /val	H, m	P, kW	Kaina FRANKLIN
4SR1M/12F-R	0,3-1,8 (1,2)	71-30 (52)	0.37	550,00
4SR1M/17F-R	0,3-1,8 (1,2)	100-42,5 (74)	0.55	609,00
4SR2M/9F-R	0,6-3,9 (2,4)	67-19,5 (49,5)	0.55	560,00
4SR2M/12F-R	0,6-3,9 (2,4)	90-25,7 (66,2)	0.75	590,00
4SR2M/17F-R	0,6-3,9 (2,4)	127-36,4 (94)	1.1	685,00
4SR4M/12F-R	1,2-6,0 (4,2)	91-33,5 (66)	1.1	670,00

GARANTIJA SIURBLIAMS – 24 MĖNESIAI.
hidraulikoms 4SR1÷4SR4 – 36 mėn.,

PEDROLLO monoblokiniai giluminiai siurbliai

Markė 230 V	Q, m ³ /val	H, m	P, kW	Kaina Eur
DAVIS*	0,3-2,4	68-19	0,75	308,00
4BLOCK M2/9	0,6-3,6	67,5-26,5 (54)	0.55	377,00
4BLOCK M2/12	0,6-3,6	90-35,5 (72)	0.75	398,00
4BLOCK M2/18	0,6-3,6	135-53,5 (109)	1.1	521,00
4BLOCK M4/13	1,2-6,0	97-32,5 (71,5)	1.1	493,00



Monoblokiniai giluminiai siurbliai su paleidimo kondensatoriumi ir šilumine apsauga viduje. Pultas nereikalingas.
Maitinimo kabelio ilgis – 20 m. Smėlio kiekis vandenyje - iki 150 mg/l * - tik švariam vandeniui be smėlio priemaišų.

GARANTIJA SIURBLIAMS – 24 MĖNESIAI.

*Tik švariam vandeniui.

4" PEDROLLO siurblių grežiniams hidraulinės dalys (EU 547/2012,MEI≥0,40)

Markė	Q, m ³ /val	H, m	P, kW	Kaina Eur
4SR1/12F-HYD	0,3-1,8 (1,2)	71-30 (52)	0.37	248,00
4SR1/17F-HYD	0,3-1,8 (1,2)	100-42,5 (74)	0.55	294,00
4SR1/22F-HYD	0,3-1,8 (1,2)	130-55 (96)	0.75	353,00
4SR1/32F-HYD	0,3-1,8 (1,2)	188-80 (139)	1.1	508,00
4SR1/42F-HYD	0,3-1,8 (1,2)	247-105 (183)	1.5	657,00
4SR1.5/7F-HYD	0,3-2,7 (1,5)	50-18 (40)	0.37	217,00
4SR1.5/11F-HYD	0,3-2,7 (1,5)	78-28 (62,5)	0.55	244,00
4SR1.5/15F-HYD	0,3-2,7 (1,5)	105-37 (85)	0.75	287,00
4SR1.5/22F-HYD	0,3-2,7 (1,5)	151-46 (122)	1.1	403,00
4SR1.5/30F-HYD	0,3-2,7 (1,5)	202-63 (164)	1.5	880,00
4SR2/6F-HYD	0,6-3,9 (2,4)	45-13 (33)	0.37	218,00
4SR2/9F-HYD	0,6-3,9 (2,4)	67-19,5 (49,5)	0.55	241,00
4SR2/12F-HYD	0,6-3,9 (2,4)	90-25,7 (66,2)	0.75	245,00
4SR2/17F-HYD	0,6-3,9 (2,4)	127-36,4 (94)	1.1	317,00
4SR2/23F-HYD	0,6-3,9 (2,4)	172-49 (127)	1.5	404,00
4SR2/33F-HYD	0,6-3,9 (2,4)	246-71 (182)	2.2	520,00
4SR4/6F-HYD	1,2-6,0 (4,2)	45,5-17 (33)	0.55	249,00
4SR4/8F-HYD	1,2-6,0 (4,2)	60,5-22,5 (44)	0.75	253,00
4SR4/12F-HYD	1,2-6,0 (4,2)	91-33,5 (66)	1.1	317,00
4SR4/15F-HYD	1,2-6,0 (4,2)	114-42 (83)	1.5	352,00
4SR4/22F-HYD	1,2-6,0 (4,2)	167-61,5 (121)	2.2	489,00
4SR4/30F-HYD	1,2-6,0 (4,2)	228-84 (165)	3.0	540,00
4SR6/4F-HYD	1,5-9,0 (6,0)	25,5-9,5 (19,8)	0.55	283,00
4SR6/6F-HYD	1,5-9,0 (6,0)	38-14,5 (29,5)	0.75	288,00
4SR6/9F-HYD	1,5-9,0 (6,0)	57-21,5 (44,5)	1.1	343,00
4SR6/13F-HYD	1,5-9,0 (6,0)	83-31,5 (64,5)	1.5	391,00
4SR6/17F-HYD	1,5-9,0 (6,0)	108-41 (84)	2.2	512,00
4SR6/24F-HYD	1,5-9,0 (6,0)	152-58 (119)	3	627,00
4SR6/32F-HYD	1,5-9,0 (6,0)	203-77 (159)	4	802,00
4SR8/4F-HYD	2,4-12 (8,4)	26-6,5 (19,4)	0.75	275,00
4SR8/7F-HYD	2,4-12 (8,4)	46-11,5 (34)	1.1	333,00
4SR8/9F-HYD	2,4-12 (8,4)	59-15 (43,5)	1.5	350,00
4SR8/13F-HYD	2,4-12 (8,4)	85-21,5 (63)	2.2	478,00
4SR8/17F-HYD	2,4-12 (8,4)	111-28 (82)	3	564,00
4SR8/24F-HYD	2,4-12 (8,4)	151-38 (116)	4	713,00
4SR8/32F-HYD	2,4-12 (8,4)	203-51 (155)	5.5	836,00
4SR10/7-N-HYD	3,0-15	41-8,5 (26)	1.1	285,00
4SR10/9-N-HYD	3,0-15	53-10,5 (34)	1.5	350,00
4SR10/13-N-HYD	3,0-15	77-15,5 (50)	2.2	490,00
4SR10/18-N-HYD	3,0-15	106-21 (70)	3	589,00
4SR10/24-N-HYD	3,0-15	141-28,5 (93)	4	728,00
4SR10/32-N-HYD	3,0-15	189-38 (124)	5.5	840,00
4SR10/43-N-HYD	3,0-15	254-51 (166)	7.5	954,00
4SR12/5-N-HYD	3,0-18	25-5 (16,5)	0.75	271,00
4SR12/7-N-HYD	3,0-18	35-7 (23)	1.1	311,00
4SR12/9-N-HYD	3,0-18	45-9 (30)	1.5	398,00
4SR12/14-N-HYD	3,0-18	70-14 (46)	2.2	500,00
4SR12/19-N-HYD	3,0-18	95-19 (63)	3	606,00
4SR12/25-N-HYD	3,0-18	125-25 (83)	4	741,00
4SR12/34-N-HYD	3,0-18	170-34 (112)	5.5	1060,00
4SR12/41-N-HYD	3,0-18	197-41 (135)	7.5	1219,00
4SR15/6-N-HYD	3,0-20,4	30-3 (17)	1.1	320,00
4SR15/8-N-HYD	3,0-20,4	40-5 (23)	1.5	384,00
4SR15/12-N-HYD	3,0-20,4	60-7 (35)	2.2	474,00
4SR15/16-N-HYD	3,0-20,4	80-9 (46)	3	582,00
4SR15/21-N-HYD	3,0-20,4	105-12 (61)	4	706,00
4SR15/29-N-HYD	3,0-20,4	145-17 (85)	5.5	903,00
4SR15/39-N-HYD	3,0-20,4	195-23,5 (113)	7.5	1161,00



Pastaba: skaičius siurblio pavadinime po raidžių SR rodo optimalų siurblio našumą m³/val . Stulpelyje H skliaustuose esantis skaičius rodo slėgį prie optimalaus našumo.
GARANTIJA: hidraulikoms 4SR1÷4SR4 – 36 mėn., 4SR6÷4SR15 – 24 mėn

4" PEDROLLO siurblių grežiniams hidraulinės dalys

Markė	Q, m ³ /val	H, m	P, kW	Kaina Eur su PVM
4SR10/5-HYD	3,0-15	31-10 (21)	1.1	271,00
4SR10/7-HYD	3,0-15	43-15 (30)	1.5	304,00
4SR10/10-HYD	3,0-15	62-20 (42)	2.2	383,00
4SR10/15-HYD	3,0-15	92-30 (64)	3	514,00
4SR10/20-HYD	3,0-15	123-40 (85)	4	638,00
4SR10/26-HYD	3,0-15	160-52 (110)	5.5	868,00
4SR10/35-HYD	3,0-15	216-70 (148)	7.5	1107,00
4SR12/4-HYD	3,0-18	24-8 (16)	1.1	271,00
4SR12/6-HYD	3,0-18	37-14 (28)	1.5	311,00
4SR12/9-HYD	3,0-18	55-22 (42)	2.2	398,00
4SR12/12-HYD	3,0-18	73-29 (56)	3	500,00
4SR12/16-HYD	3,0-18	97-38 (75)	4	606,00
4SR12/22-HYD	3,0-18	135-53 (103)	5.5	721,00
4SR12/29-HYD	3,0-18	176-71 (135)	7.5	1060,00
4SR15/5-HYD	3,0-22,5	30-7,5 (20)	1.5	320,00
4SR15/7-HYD	3,0-22,5	42-10 (27)	2.2	384,00
4SR15/10-HYD	3,0-22,5	60-15 (38)	3	474,00
4SR15/13-HYD	3,0-22,5	77-19 (50)	4	582,00
4SR15/18-HYD	3,0-22,5	108-27 (71)	5.5	706,00
4SR15/24-HYD	3,0-22,5	145-36 (95)	7.5	903,00

Pastaba: skaičius siurblio pavadinime po raidžių SR rodo optimalų siurblio našumą m³/val.
Stulpelyje H skliaustuose esantis skaičius rodo slėgį prie optimalaus našumo.

GARANTIJA: hidraulikoms – 24 mėn

Aušinimo vamzdžiai 4" siurbliams

Variklio galingumas kW	Franklin		Kodas	Kaina, Eur	Pedrollo		Kodas	Kaina, Eur
	230 V	400 V			230 V	400 V		
0,37	+	+	ASSKIT4SRCR1	204,00	+	+	ASSKIT4SRCR2	216,00
0,55	+	+			+	+		
0,75		+			+	+		
0,75	+		ASSKIT4SRCR2	216,00			ASSKIT4SRCR3	227,00
1,1	+	+			+	+		
1,5	+	+			+	+		
2,2		+			+	+		
2,2	+		ASSKIT4SRCR3	227,00			ASSKIT4SRCR4	237,00
3,0		+				+		
4,0		+	ASSKIT4SRCR4	237,00		+		
5,5		+				+		
7,5		+				+		

Aušinimo vamzdžiai 6" siurbliams

Variklio galingumas kW	Kodas	Kaina, Eur
4,0	ASSKIT6SRCR1	427,00
5,5		
7,5		
9,2		
11	ASSKIT6SRCR2	443,00
15		
18,5	ASSKIT6SRCR3	464,00
22		
30		

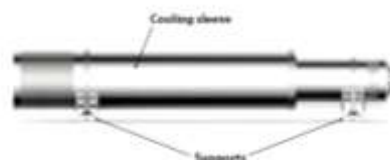

Komplektą sudaro:

- aušinimo vamzdis su filtru
- variklio tarpiklis
- sandarinimo tarpinė
- atramos horizontaliam montavimui 2 vnt., sąvaržos 3 vnt

4" PEDROLLO siurblių grežiniams hidraulinės dalys
iš nerūdijančio plieno AISI 304



Markė	Q, m ³ /val	H, m	P, kW	Kaina, Eur su PVM
4HR10/5-HYD*	3,0-15,0	25,5-7 (17)	0.75	702,00
4HR10/7-HYD*	3,0-15,0	36-10 (24)	1.1	835,00
4HR10/10-HYD*	3,0-15,0	51,5-14 (34)	1.5	1101,00
4HR10/15-HYD*	3,0-15,0	77-21 (52)	2.2	1579,00
4HR10/20-HYD*	3,0-15,0	103-28 (68)	3	2075,00
4HR10/28-HYD*	3,0-15,0	144-39 (96)	4	2716,00
4HR14/6-HYD*	3,0-20,4	29,5-9 (20)	1.1	702,00
4HR14/8-HYD*	3,0-20,4	39,5-12 (26,5)	1.5	835,00
4HR14/12-HYD*	3,0-20,4	59-18 (40)	2.2	1186,00
4HR14/16-HYD*	3,0-20,4	79-23,5 (54)	3	1525,00
4HR14/21-HYD*	3,0-20,4	104-31 (70,5)	4	1912,00
4HR14/29-HYD*	3,0-20,4	143-43 (98)	5.5	2577,00
4HR18/4-HYD*	3,0-25,2	22-5 (13,5)	1.1	545,00
4HR18/6-HYD	3,0-25,2	33,5-7 (20,3)	1.5	714,00
4HR18/9-HYD	3,0-25,2	50-11 (30,5)	2.2	920,00
4HR18/12-HYD	3,0-25,2	66,5-14,5 (40,5)	3	1198,00
4HR18/16-HYD	3,0-25,2	89-19 (54)	4	1537,00
4HR18/22-HYD	3,0-25,2	122-26,5 (74)	5.5	2020,00
4HR18/30-HYD	3,0-25,2	167-36 (101)	7.5	2674,00



* Dėl pristatymo termino klausti papildomai.

Pastaba: skaičius siurblio pavadinime po raidžių HR rodo optimalų siurblio našumą m³/val.
 Stulpelyje H skliaustuose esantis skaičius rodo slėgį prie optimalaus našumo.

GARANTIJA: hidraulikoms – 24 mėn.

6" PEDROLLO giluminiai siurbliai su Franklin ir Pedrollo varikliais

Markė 400 V	Q, m ³ /val	H, m	P, kW	Kaina Fraklin, Eur su PVM	Kaina Pedrollo, Eur su PVM
6SR12/8	3.0-19.8	106-32 (80)	4	2298,00	1987,00
6SR12/11	3.0-19.8	146-44 (110)	5.5	2415,00	2102,00
6SR12/15	3.0-19.8	199-60 (150)	7.5	2654,00	2261,00
6SR12/18	3.0-19.8	239-72 (180)	9.3	2846,00	2445,00
6SR12/21	3.0-19.8	279-84 (210)	11	3011,00	2557,00
6SR12/25	3.0-19.8	331-100 (250)	13	3427,00	2926,00
6SR12/28	3.0-19.8	371-112 (280)	15	3584,00	3001,00
6SR18/4	3,0-27	53,8-22 (42)	4	2196,00	1901,00
6SR18/6	3,0-27	80,5-32 (63)	5.5	2298,00	1988,00
6SR18/9	3,0-27	121-48 (94)	7.5	2467,00	2108,00
6SR18/11	3,0-27	148-59 (115)	9.3	2642,00	2255,00
6SR18/13	3,0-27	175-70 (136)	11	2817,00	2381,00
6SR18/15	3,0-27	202-80 (157)	13	3197,00	2698,00
6SR18/18	3,0-27	242-96 (188)	15	3340,00	2774,00
6SR18/22	3,0-27	296-118 (230)	18.5	3540,00	3127,00
6SR18/26	3,0-27	350-139 (272)	22	3940,00	3622,00
6SR27/5	6,0-36	66-22 (44)	5.5	2298,00	1901,00
6SR27/7	6,0-36	92-31 (61)	7.5	2436,00	1989,00
6SR27/8	6,0-36	106-35 (70)	9.3	2589,00	2070,00
6SR27/10	6,0-36	132-44 (87)	11	2730,00	2218,00
6SR27/12	6,0-36	159-53 (105)	13	3142,00	2306,00
6SR27/14	6,0-36	185-62 (122)	15	3197,00	2660,00
6SR27/17	6,0-36	224-75 (148)	18.5	3478,00	2711,00
6SR27/20	6,0-36	264-88 (175)	22	3841,00	3052,00
6SR27/27	6,0-36	356-119 (240)	30	4859,00	3533,00
6SR36/4	6,0-48	45-14 (25)	4	2636,00	2457,00
6SR36/6	6,0-48	67-20 (37)	5.5	2867,00	2698,00
6SR36/8	6,0-48	89-27 (50)	7.5	3115,00	2907,00
6SR36/10	6,0-48	111-34 (62)	9.3	3415,00	3191,00
6SR36/11	6,0-48	123-37 (68)	11	3579,00	3331,00
6SR36/13	6,0-48	145-44 (81)	13	4098,00	3800,00
6SR36/15	6,0-48	167-51 (93)	15	4257,00	3963,00
6SR36/19	6,0-48	212-65 (118)	18.5	4764,00	4597,00
6SR36/23	6,0-48	256-78 (143)	22	5395,00	5344,00
6SR44/3	12-60	33-13 (23)	4	2548,00	2368,00
6SR44/4	12-60	44-18 (31)	5.5	2685,00	2509,00
6SR44/5	12-60	54-22 (38)	7.5	2867,00	2642,00
6SR44/6	12-60	65-26 (46)	9.3	3085,00	2850,00
6SR44/8	12-60	87-35 (61)	11	3328,00	3066,00
6SR44/9	12-60	98-39 (69)	13	3735,00	3432,00
6SR44/11	12-60	120-48 (84)	15	3903,00	3610,00
6SR44/13	12-60	141-57 (99)	18.5	4278,00	4065,00
6SR44/16	12-60	174-70 (122)	22	4798,00	4723,00
6SR44/21	12-60	228-92 (160)	30	6031,00	5597,00



Pastaba: skaičius siurblio pavadinime po raidžių SR rodo optimalų siurblio našumą m³/val. Stulpelyje H skliaustuose esantis skaičius rodo slėgį prie optimalaus našumo.

GARANTUOJA SIURBLIAMS – 12 MĖNESIŲ.

6" PEDROLLO siurblių grežiniams hidraulinės dalys



iš nerūdijančio plieno AISI 304

Markė	Q, m ³ /val	H, m	P, kW	Kaina, Eur su PVM
6HR34/3-HYD	6,0-48,0	40-19 (30)	4	1059,00
6HR34/4-HYD	6,0-48,0	53-25,5 (40)	5.5	1222,00
6HR34/5-HYD	6,0-48,0	66,5-32 (55)	7.5	1392,00
6HR34/7-HYD	6,0-48,0	93-45 (72)	11	1712,00
6HR34/8-HYD	6,0-48,0	106-51 (82)	11	1863,00
6HR34/9-HYD	6,0-48,0	120-58 (92)	13	2033,00
6HR34/11-HYD	6,0-48,0	146-70 (112)	15	2396,00
6HR34/13-HYD	6,0-48,0	173-83 (132)	18,5	2735,00
6HR34/16-HYD	6,0-48,0	213-102 (157)	22	3219,00
6HR34/19-HYD	6,0-48,0	253-122 (195)	26	3691,00
6HR34/22-HYD	6,0-48,0	293-141 (225)	30	4211,00
6HR34/27-HYD	6,0-48,0	359-173 (277)	37	5022,00
6HR44/4-HYD	12,0-60,0	51-23 (35)	7.5	1222,00
6HR44/5-HYD	12,0-60,0	63,5-29 (44)	7.5	1392,00
6HR44/6-HYD	12,0-60,0	76-35 (52)	9.2	1549,00
6HR44/7-HYD	12,0-60,0	89-40,5 (62)	11	1718,00
6HR44/9-HYD	12,0-60,0	114,5-52 (77)	13	2033,00
6HR44/10-HYD	12,0-60,0	127-58 (87)	15	2202,00
6HR44/12-HYD	12,0-60,0	152-70 (105)	18,5	2577,00
6HR44/15-HYD	12,0-60,0	191-87 (132)	22	3134,00
6HR44/18-HYD	12,0-60,0	229-104 (157)	26	3642,00
6HR44/20-HYD	12,0-60,0	254-116 (175)	30	3908,00
6HR44/25-HYD	12,0-60,0	318-145 (217)	37	4743,00
6HR54/3-HYD	18,0-72,0	34-16 (24)	5.5	1077,00
6HR54/4-HYD	18,0-72,0	45,5-21 (32)	7.5	1222,00
6HR54/5-HYD	18,0-72,0	57-26,5 (40)	9.2	1392,00
6HR54/6-HYD	18,0-72,0	68,5-31,5 (48)	11	1549,00
6HR54/8-HYD	18,0-72,0	91-42 (64)	13	1876,00
6HR54/9-HYD	18,0-72,0	103-47 (72)	15	2033,00
6HR54/11-HYD	18,0-72,0	125-58 (88)	18,5	2396,00
6HR54/13-HYD	18,0-72,0	148-68 (104)	22	2735,00
6HR54/16-HYD	18,0-72,0	182-84 (128)	26	3219,00
6HR54/18-HYD	18,0-72,0	205-95 (144)	30	3654,00
6HR54/22-HYD	18,0-72,0	251-116 (176)	37	4211,00
6HR64/3-HYD	24,0-90,0	33-15 (26)	7.5	1059,00
6HR64/4-HYD	24,0-90,0	43,5-20 (33)	9.2	1222,00
6HR64/5-HYD	24,0-90,0	54,5-25 (42)	11	1392,00
6HR64/6-HYD	24,0-90,0	65,5-30 (52)	13	1549,00
6HR64/7-HYD	24,0-90,0	76-35 (60)	15	1712,00
6HR64/8-HYD	24,0-90,0	87-40 (67)	18,5	1876,00
6HR64/10-HYD	24,0-90,0	109-50 (86)	22	2202,00
6HR64/12-HYD	24,0-90,0	131-60 (102)	26	2577,00
6HR64/14-HYD	24,0-90,0	153-70 (120)	30	2783,00
6HR64/17-HYD	24,0-90,0	153-70 (142)	37	3660,00



* Dėl pristatymo termino klausti papildomai.

Pastaba: skaičius siurblio pavadinime po raidžių HR rodo optimalų siurblio našumą m³/val.

Stulpelyje H skliaustuose esantis skaičius rodo slėgį prie optimalaus našumo.

GARANTIJA: hidraulikoms – 24 mėn.

PEDROLLO 3" giluminiai siurbliai su Pedrollo varikliais



Markė 230 V	Markė 400 V	P, kW	H, m	Q, m ³ /val	Pajungimas	Kaina 230 V	Kaina 400 V
3SR2M/14	3SR2/14	0,37	57-16,5 (43)	0,6-2,7	1"	386,00	386,00
3SR2M/21	3SR2/21	0,55	84-23,5 (62)	0,6-2,7	1"	422,00	422,00
3SR2M/28	3SR2/28	0,75	109-28,5 (81)	0,6-2,7	1"	477,00	477,00
-	3SR2/41	1,1	154-35,5 (113)	0,6-2,7	1"	-	549,00

GARANTIJA SIURBLIAMS – 24 MĖNESIAI.

PEDROLLO varikliai giluminiams siurbliams



4" Vienfaziai varikliai 230 V

Markė	KW	Startinė srovė nominali srovė I_n	Nominali srovė I_n A	Įtampa, V	Sukimo moment. N	Kondensatorius μF	Svoris kg	Kaina, Eur
4PDM / 0.50	0,37	3,3	3,6	230	2000	20	6,5	202,00
4PDM / 0.75	0,55	3,5	4,7	230	2000	25	7,2	207,00
4PDM / 1	0,75	3,2	5,9	230	2000	35	8,5	212,00
4PDM / 1.5	1,1	3,2	8,3	230	2000	40	10,2	248,00
4PDM / 2	1,5	3,3	10,7	230	2000	60	11,7	308,00
4PDM / 3	2,2	3,1	15,2	230	2000	75	14,9	393,00

GARANTIJA: varikliams PEDROLLO 0,37-1,1 Kw 230 V -36 mėn, kiti – 24 mėn.

4" Trifaziai varikliai 400 V

Markė	KW	Startinė srovė nominali srovė I_n	Nominali srovė I_n A	Įtampa, V	Sukimo moment. N	Galios faktorius $\cos\phi$	Svoris kg	Kaina, Eur
4PD / 0.50	0,37	3,2	1,8	400	2000	0,52	6,5	202,00
4PD / 0.75	0,55	4	2,0	400	2000	0,63	7,2	207,00
4PD / 1	0,75	3,8	2,5	400	2000	0,71	8,5	212,00
4PD / 1.5	1,1	4,6	3,4	400	2000	0,79	9,4	248,00
4PD / 2	1,5	3,8	4,8	400	2000	0,66	10,2	266,00
4PD / 3	2,2	6,5	6,1	400	2000	0,73	11,7	343,00
4PD / 4	3	5,6	7,1	400	3000	0,79	15,0	420,00
4PD / 5.5	4	5,4	9,2	400	5000	0,77	20,1	573,00
4PD / 7.5	5,5	5,5	11,7	400	5000	0,82	24,7	695,00
4PD / 10	7,5	5,4	16,4	400	5000	0,76	29,0	808,00

Minimalus aušinimo srautas – 8 cm/s,
Maksimali vandens temperatūra – 35⁰C
Įsijungimų skaičius per valandą – iki 20 vienodais intervalais
Apsaugos klasė – IP68

6" Trifaziai varikliai 400V

Markė	KW	Startinė srovė nominali srovė I_n	Nominali srovė I_n A	Įtampa, V	Sukimo moment. N	Galios faktorius $\cos\phi$	Svoris kg	Kaina, Eur
6PD / 5.5	4	4,0	9,5	400	10000	0,81	34	1030,00
6PD / 7.5	5,5	4,0	13,0	400	10000	0,79	36	1061,00
6PD / 10	7,5	4,0	16,8	400	10000	0,82	39	1097,00
6PD / 12.5	9,3	4,1	20,9	400	10000	0,80	42	1195,00
6PD / 15	11	5,4	25,3	400	10000	0,75	50	1236,00
6PD / 20	15	5,5	33,4	400	10000	0,79	57	1473,00
6PD / 25	18,5	4,6	40,7	400	10000	0,79	65	1700,00
6PD / 30	22	5,5	53,3	400	20000	0,71	87	2019,00
6PD / 40	30	5,0	61,9	400	20000	0,85	91	2369,00

Minimalus aušinimo srautas – 16 cm/s , 30 kw - 50 cm/s,
Maksimali vandens temperatūra – 35⁰C
Įsijungimų skaičius per valandą – iki 20 vienodais intervalais
Apsaugos klasė – IP68





GARANTIJA: varikliams 400 V 0,37÷1,10 kW – 24 mėn., nuo 1,5 kW ir daugiau – 12 mėn.

Markė 230 V	Markė 400V	Galia, kW	Našumas l/min	Slėgis, m	Pajung. diametr.	Kaina, € 230V	Kaina, € 400V	
TOP 1	—	0,25	20-160	6-1	1 1/4"	127,00	—	
TOP 2	—	0,37	20-220	8-1	1 1/4"	133,00	—	
TOP 3	—	0,5	20-260	10-2	1 1/4"	179,00	—	
TOP 4-N	—	0,75	20-320	12.5-3	1 1/2"	278,00	—	
TOP 5-N	—	0,92	20-360	15-2.5	1 1/2"	289,00	—	
TOP 2 LA	—	0,37	20-220	8-1	1 1/4"	219,00	—	
TOP 3 LA	—	0,5	20-260	10-2	1 1/4"	246,00	—	
TOP 1 - GM	—	0,25	20-160	6-1	1 1/4"	165,00	—	
TOP 2 - GM	—	0,37	20-220	8-1	1 1/4"	172,00	—	
TOP 3 - GM	—	0,5	20-260	10-2	1 1/4"	197,00	—	
TOP 4-N - GM	—	0,75	20-320	12.5-3	1 1/2"	302,00	—	
TOP 5-N - GM	—	0,92	20-360	15-2.5	1 1/2"	314,00	—	
TOP 1 FLOOR	—	0,25	20-120	6-1	1 1/4"	155,00	—	
TOP 2 FLOOR	—	0,37	20-160	8-1	1 1/4"	160,00	—	
TOP MULTI 2	—	0,55	10-80	40-5	1 1/4"	250,00	—	
TOP MULTI 3	—	0,75	10-120	32-4	1 1/4"	274,00	—	
TOP MULTI 4	—	0,75	10-80	50-6	1 1/4"	339,00	—	
TOP MULTI-TECH 2	—	0,55	10-80	40-5	1 1/4"	340,00	—	
TOP MULTI-TECH 3	—	0,75	10-120	32-4	1 1/4"	396,00	—	
TOP MULTI 2-EVO	—	0,55	10-80	40-5	1 1/4"	309,00	—	
TOP MULTI 3-EVO	—	0,75	10-120	32-4	1 1/4"	328,00	—	
TOP MULTI-EVOTECH 2	—	0,55	10-80	40-5	1 1/4"	394,00	—	
TOP MULTI-EVOTECH 3	—	0,75	10-120	32-4	1 1/4"	418,00	—	
TOP 2 VORTEX	—	0,37	20-180	6,5-1,5	1 1/4"	147,00	—	
TOP 3 VORTEX	—	0,55	20-180	8-2,5	1 1/4"	171,00	—	
TOP 2 VORTEX-GM	—	0,37	20-180	6,5-1,5	1 1/4"	190,00	—	
TOP 3 VORTEX-GM	—	0,55	20-180	8-2,5	1 1/4"	213,00	—	
TEX 2	—	0,37	20-200	7,5-1,5	1 1/4"	190,00	—	
TEX 3	—	0,55	20-200	9,5-2	1 1/4"	205,00	—	
RXM 1	RX 1	0,25	20-160	6.5-1	1 1/4"	201,00	219,00	
RXM 2	RX 2	0,37	20-220	9.5-2	1 1/4"	213,00	231,00	
RXM 3	RX 3	0,55	20-220	11,5-3	1 1/4"	226,00	257,00	
RXM 4	RX 4	0,75	20-260	15-4	1 1/2"	620,00	620,00	
RXM 5	RX 5	1,1	20-300	19.5-5	1 1/2"	649,00	649,00	
RXM 1 - GM	-	0,25	20-160	6.5-1	1 1/4"	227,00	—	
RXM 2 - GM	-	0,37	20-220	9.5-2	1 1/4"	236,00	—	
RXM 3 - GM	-	0,55	20-220	11,5-3	1 1/4"	263,00	—	
RXM 4 - GM	-	0,75	20-260	15-4	1 1/2"	657,00	—	
RXM 5 - GM	-	1,1	20-300	19.5-5	1 1/2"	684,00	—	
RXM 2/20	RX 2/20	0,37	20-180	6,5-2	1 1/4"	226,00	241,00	
RXM 3/20	RX 3/20	0,55	20-180	8-3	1 1/4"	246,00	268,00	
RXM 4/40	RX 4/40	0,75	20-280	9,5-2	1 1/2"	649,00	649,00	
RXM 5/40	RX 5/40	1,1	20-380	12,5-2	1 1/2"	674,00	674,00	
DM 8-N	D 8-N	0,55	25-250	12,5-3	1 1/2"	317,00	335,00	
DM 10-N	D 10-N	0,75	25-300	15,5-3	1 1/2"	332,00	343,00	
DM 20 -N	D 20-N	0,75	25-250	19-8	1 1/2"	335,00	356,00	
DM 30 -N	D 30-N	1,1	25-275	26-9	1 1/2"	402,00	402,00	
DCM 8-N	DC 8-N	0,55	25-250	12,5-3	1 1/2"	352,00	370,00	
DCM 10-N	DC 10-N	0,75	25-300	15,5-3	1 1/2"	357,00	370,00	
DCM 20-N	DC 20-N	0,75	25-250	19-8	1 1/2"	364,00	375,00	
DCM 30-N	DC 30-N	1,1	25-275	26-9	1 1/2"	400,00	400,00	

GARANTIJA SIURBLIAMS – 24 MĖNESIAI.

Markė 230 V	Markė 400V	Galia kW	Našumas l/min	Slėgis m	Pajungimo diametras	Kaina, € 230V	Kaina, € 400V	
ZXM 1B/40	—	0,5	25-350	8,5-1	1 1/2"	249,00	—	
ZXM 1A/40	—	0,6	25-400	10,5-1,5	1 1/2"	275,00	—	
ZXM 2/30	—	0,55	25-320	12,5-2	1 1/2"	275,00	—	
ZXM2/40	—	0,55	25-400	11-2	1 1/2"	280,00	—	
ZXM2/30-GM	—	0,55	25-320	12,5-2	1 1/2"	292,00	—	
ZXM2/40-GM	—	0,55	25-400	11-2	1 1/2"	297,00	—	
VXM 8/35	VX 8/35	0,55	50-350	8-1	1 1/2"	299,00	315,00	
VXM 10/35	VX 10/35	0,75	50-400	10-2	1 1/2"	327,00	340,00	
VXM 15/35	VX 15/35	1,1	50-500	13,5-2	1 1/2"	408,00	408,00	
VXM 8/50	VX 8/50	0,55	50-450	6-1,5	2"	327,00	329,00	
VXM 10/50	VX 10/50	0,75	50-550	8,5-1,5	2"	340,00	352,00	
VXM 15/50	VX 15/50	1,1	50-650	11-2	2"	420,00	420,00	
VXM 8/35-ST	VX 8/35-ST	0,55	50-350	8,5-1	1 1/2"	352,00	371,00	
VXM 10/35-ST	VX 10/35-ST	0,75	50-400	10,5-2	1 1/2"	357,00	371,00	
VXM 15/35-ST	VX 15/35-ST	1,1	50-500	14-2	1 1/2"	420,00	420,00	
VXM 8/50-ST	VX 8/50-ST	0,55	50-450	7-1,5	2"	357,00	374,00	
VXM10/50-ST	VX10/50-ST	0,75	50-550	9,5-1,5	2"	371,00	382,00	
VXM 15/50-ST	VX 15/50-ST	1,1	50-650	13-2	2"	436,00	436,00	
VXM 8/35-MF	VX 8/35-MF	0,55	50-350	8-1	1 1/2"	560,00	573,00	
VXM 10/35-MF	VX 10/35-MF	0,75	50-400	10-2	1 1/2"	567,00	580,00	
VXM 15/35-MF	VX 15/35-MF	1,1	50-500	13,5-2	1 1/2"	608,00	608,00	
VXM 8/50-MF	VX 8/50-MF	0,55	50-450	6-1,5	2"	572,00	586,00	
VXM10/50-MF	VX10/50-MF	0,75	50-550	8,5-1,5	2"	580,00	590,00	
VXM 15/50-MF	VX 15/50-MF	1,1	50-650	11-2	2"	620,00	620,00	
VXCM 8/35	VXC 8/35	0,55	50-350	8-1	1 1/2"	382,00	400,00	
VXCM 10/35	VXC 10/35	0,75	50-400	10-2	1 1/2"	396,00	408,00	
VXCM 15/35	VXC 15/35	1,1	50-500	13,5-2	1 1/2"	456,00	456,00	
VXCM 8/45	VXC 8/45	0,55	50-450	6-1,5	2"	382,00	408,00	
VXCM 10/45	VXC 10/45	0,75	50-550	8,5-1,5	2"	396,00	414,00	
VXCM 15/45	VXC 15/45	1,1	50-650	11-2	2"	456,00	456,00	
VXCM 15/50	VXC 15/50	1,1	100-600	10,5-2	2 1/2"	855,00	855,00	
VXCM 20/50	VXC 20/50	1,5	100-700	12-2	2 1/2"	907,00	881,00	
VXCM 30/50	VXC 30/50	2,2	100-850	15-2	2 1/2"	1553,00*	907,00	
VXCM 15/70	VXC 15/70	1,1	200-850	5,5-1	3"	907,00	925,00	
VXCM 20/70	VXC 20/70	1,5	200-1000	7,4-1	3"	962,00	947,00	
VXCM 30/70	VXC 30/70	2,2	20-1200	9,7-1,5	3"	1627,00*	975,00	
VXCM 15/50-F	VXC 15/50-F	1,1	100-600	10,5-2	2 1/2"	905,00	905,00	
VXCM 20/50-F	VXC 20/50-F	1,5	100-700	12-2	2 1/2"	951,00	932,00	
VXCM 30/50-F	VXC 30/50-F	2,2	100-850	15-2	2 1/2"	1594,00*	955,00	
VXCM 15/70-F	VXC 15/70-F	1,1	200-850	5,5-1	3"	988,00	988,00	
VXCM 20/70-F	VXC 20/70-F	1,5	200-1000	7,4-1	3"	1039,00	1014,00	
VXCM 30/70-F	VXC 30/70-F	2,2	20-1200	9,7-1,5	3"	1678,00*	1039,00	
BCM 10/50-ST	BC 10/50-ST	0,75	50-600	11-2	2"	407,00	423,00	
BCM 15/50-ST	BC 15/50-ST	1,1	50-750	14-2	2"	439,00	439,00	
BCM 10/50	BC 10/50	0,75	50-600	11-2	2"	374,00	383,00	
BCM 15/50	BC 15/50	1,1	50-750	14-2	2"	432,00	432,00	
BCM 10/50-MF	BC 10/50-MF	0,75	50-600	11-2	2"	618,00	631,00	
BCM 15/50-MF	BC 15/50-MF	1,1	50-750	14-2	2"	669,00	669,00	

* - VXCM – MCM30/50-30/70 vienfaziai 2,2 kW siurbliai komplektuojami su paleidimo pultu, įskaičiuotu į kainą

Markė 230 V	Markė 400V	Galia kW	Našumas l/min	Slėgis m	Pajungimo diametras	Kaina, € 230V	Kaina, € 400V	
MCM 10/45	MC 10/45	0,75	50-600	11-2	2"	420,00	438,00	
MCM 15/45	MC 15/45	1,1	50-750	14-2	2"	481,00	481,00	
MCM 15/50	MC 15/50	1.1	100-800	14-1	2 1/2"	894,00	894,00	
MCM 20/50	MC 20/50	1.5	100-900	16-1	2 1/2"	948,00	921,00	
MCM 30/50	MC 30/50	2.2	100-1100	22-2	2 1/2"	1553,00*	991,00	
-	MC 40/50	3.0	100-1100	24-4	2 1/2"	-	1210,00	
MCM 30/70	MC 30/70	2.2	200-1500	12-2	3"	1575,00*	1066,00	
-	MC 40/70	3.0	200-1600	15-4	3"	-	1242,00	
MCM 15/50-F	MC 15/50-F	1,1	100-800	14-1	2 1/2"	961,00	961,00	
MCM 20/50-F	MC 20/50-F	1.5	100-900	16-1	2 1/2"	1001,00	974,00	
MCM 30/50-F	MC 30/50-F	2.2	100-1100	22-2	2 1/2"	1609,00*	1001,00	
-	MC 40/50-F	3.0	100-1100	24-4	2 1/2"	-	1264,00	
MCM 30/70-F	MC 30/70-F	2.2	200-1600	11,5-2	3"	1604,00*	1084,00	
-	MC 40/70-F	3.0	200-1600	15-4	3"	-	1349,00	
-	VX40/40	3.0	100-800	22-5	DN50/2"	-	1458,00	
-	VX55/40	4.0	100-850	25-6	DN50/2"	-	1565,00	
-	VX40/50	3.0	100-900	22-5,5	DN50/2"	-	1495,00	
-	VX55/50	4.0	100-1000	25-6,5	DN50/2"	-	1610,00	
-	VX40/65	3.0	200-1200	15,6-2,5	DN65/2,5"	-	1516,00	
-	VX55/65	4.0	200-1350	19,4-3,7	DN65/2,5"	-	1622,00	
-	VX75/65	5.5	200-1500	23,6-5,5	DN65/2,5"	-	1706,00	
-	BC40/35	3	300-1500	18,5-5,5	DN65/2,5"	-	1647,00	
-	BC55/35	4	300-1700	22,5-7,5	DN65/2,5"	-	1740,00	
-	BC75/35	5.5	300-1900	27,5-10	DN65/2,5"	-	1823,00	

* - VXC – MC vienfaziai 2,2 kW siurbliai komplektuojami su paleidimo pultu, įskaičiuota j kaina

Montavimo komplektai siurbliams VX/35-ST/MF, VX/50-ST/MF, BC/50-ST/MF

Kodas	Aprašymas	Pajungimo diametras	Kaina, €	
ASSPVX35ST	Montavimo komplektas su horizontaliu išėjimu siurbliams VX /35-ST-MF	2"	79,00	
ASSPVX50ST	Montavimo komplektas su horizontaliu išėjimu siurbliams VX /50-ST-MF, BC /50-ST-MF	2"	85,00	
ASSPVX35STV	Montavimo kompl. su vert. išėjimu VX /35-ST-MF	2 1/2"	185,00	
ASSPVX50STV	Montavimo kompl. su vert. išėjimu VX /50-ST-MF, BC /50-ST-MF	2 1/2"	185,00	

Montavimo komplektai fekaliniams siurbliams VXC/-F, MC/-F

Kodas	Aprašymas	Pajungimo diametras	Kaina, €	
ASSPVXC050	Hor. mont. kompl. siurbliams VXC/50-F, MC/50-F	2 1/2"	144,00	
ASSPVXC050V	Vert. mont. komplektas VXC/50-F, MC/50-F	2 1/2"	184,00	
ASSPVXC070V	Vert. mont. komplektas VXC/70-F, MC/70-F	3"	225,00	
ASSPVX50	Hor. montavimo komplektas siurbliams VX/50	2 1/2"	170,00	
ASSPVX503V	Vert. mont. komplektas siurbliams VX/50	2 1/2"	220,00	
ASSPVX653V	Vert. Mont. komplektas siurbliams VX/65, BC/35	3"	305,00	
ASSPVX65V	Vert. Mont. komplektas siurbliams VX/65, BC/35	3"	860,00	

PEDROLLO siurbliai su smulkintuvu TRITUS



Markė 230 V	Markė 400V	Galia kW	Našumas l/min	Slėgis m	Pajungimas	Kaina, € 230V	Kaina, € 400V	
TRITUS TRM0.75	TRITUS TR0.75	0,75	10-120	15,7-4	11/4"	700,00	670,00	
TRITUS TRM0.9	TRITUS TR0.9	0,9	10-140	15,5-6	11/4"	730,00	695,00	
TRITUS TRM1.1	TRITUS TR1.1	1,1	10-125	22-9,5	11/4"	757,00	716,00	
TRITUS TRM1.3	TRITUS TR1.3	1,3	10-200	23-6,2	11/4"	775,00	735,00	
TRITUS TRM1.5	TRITUS TR1.5	1,5	10-240	25,5-8	DN40	1272,00	1185,00	
-	TRITUS TR2.2	2,2	10-270	30,5-15	DN40	-	1267,00	

Montavimo komplektai siurbliams TRITUS

Kodas	Aprašymas	Pajungimo diametras	Kaina, €	
ASSPTRITUS11	Montavimo komplektas su horizontaliu išėjimu siurbliams TR0.75 - TR1.3	2"	115,00	
ASSPTRITUS22	Montavimo komplektas su horizontaliu išėjimu siurbliams TR1.5 - TR2.2	2"	115,00	
ASSPTRITUS11V	Montavimo kompl. su vert. išėjimu TR0.75 - TR1.3	2"	185,00	
ASSPTRITUS22V	Montavimo kompl. su vert. išėjimu TR1.5 - TR2.2	2 1/2"	185,00	

GARANTIJA SIURBLIAMS – 24 MĖNESIAI.

Nuotėkų siurblinės PEDROLLO



Modelis	Talpa l	Galia kW	Našumas maks l/min	Slėgis maks m	Išmatavimai PxGxA, mm	Kaina, €
SAR40-RXM1	40	0,25	160	6,5	410x370x410	487,00
SAR100-ZXM1A/40	100	0,60	400	10,5	690x500x645	788,00
SAR100-TRM1.1	100	0,60	120	22	690x500x645	1288,00
SAR250-VXM15/35	250	1,1	450	14	725x880x880	1205,00
SAR250-TRM1.1	250	1,1	120	22	725x880x880	1535,00
SAR550-VXM15/50	550	2x1,1	2x500	10,5	1475x880x880	2853,00

GARANTIJA SIURBLIAMS – 24 MĖNESIAI, TALPOMS – 10 METU.

KSKIT-300MA	Paaukštėjimas 300 mm SAR250-550 montavimui giliau po žeme	134,00
KSKIT-ALLARME	Signalizacijos komplektas komplektą įeina: plūdinis jungiklis, autonominė sirena, pultas	417,00

SAR40

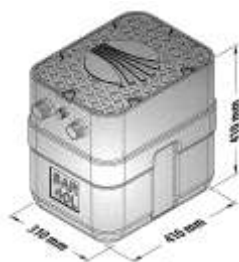

SAR100

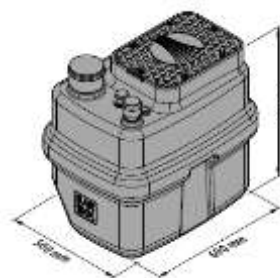

SAR250

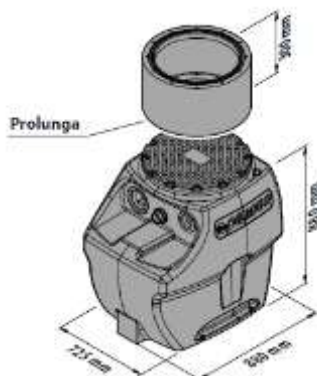

SAR550

